



## RAVENNA - V

De RAVENNA - V is strak vormgegeven en staat prachtig in elke ruimte van het huis. Door de vele buizen geeft deze radiator snel veel warmte af. De RAVENNA - V is in verschillende maten en in bijna elke kleur te krijgen. Leverbaar met opliggende verticale buizen van 25mm en 13mm en in een enkele en dubbele uitvoering. De ophanging is in de kleur van de radiator en wordt samen met de ontluchting meegeleverd. De radiator wordt na een grondige roestwerende voorbehandeling voorzien van een poeder-epoxylaag.



Radiator RAV 25.180.9  
 Kleur Standaard wit  
 Aansluitset Cylinder

## TECHNISCHE GEGEVENS RAVENNA - V

**Ravenna 25**  
 Buisdiameter 25mm

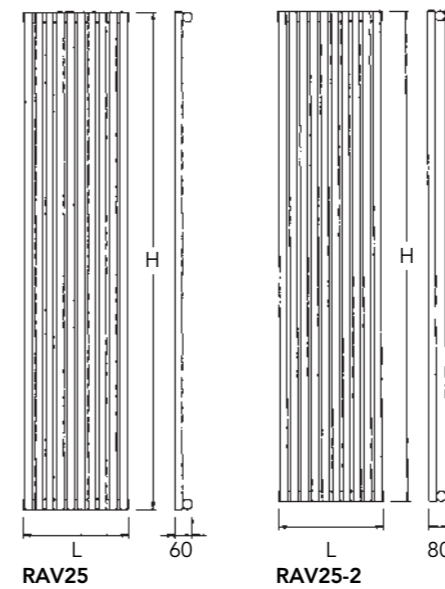

**Ravenna 13**  
 Buisdiameter 13mm

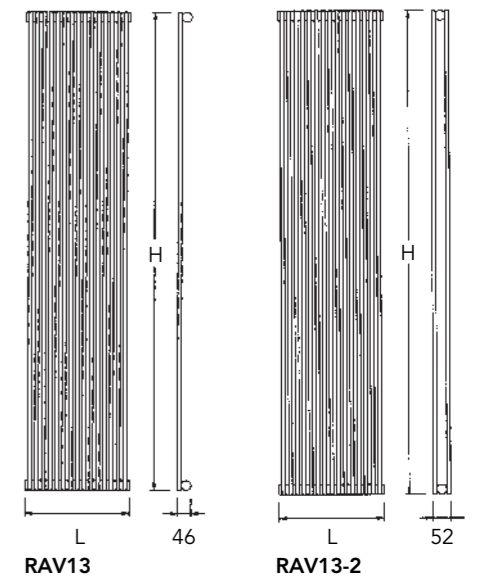

Indien de opliggende elementen hoger/langer zijn 1400mm, worden er aan de achterzijde van de radiator twee versterkingsstrips gemonteerd.

### AANSLUITPOSITIES RAV

Het type RAV is standaard voorzien van 4 aansluitingen 1/2". Deze 4 aansluitingen zijn als volgt te gebruiken:



Daarnaast zijn er voor het type RAV een aantal speciale aansluitingen waarvoor een meerprijs geldt.

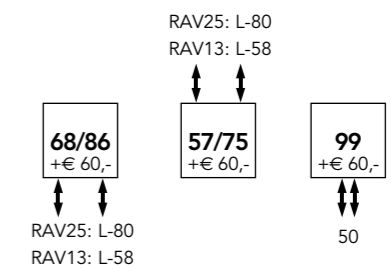

### LET OP!

De gewenste aansluitpositie dient te worden opgegeven bij bestelling!

### OPHANGING

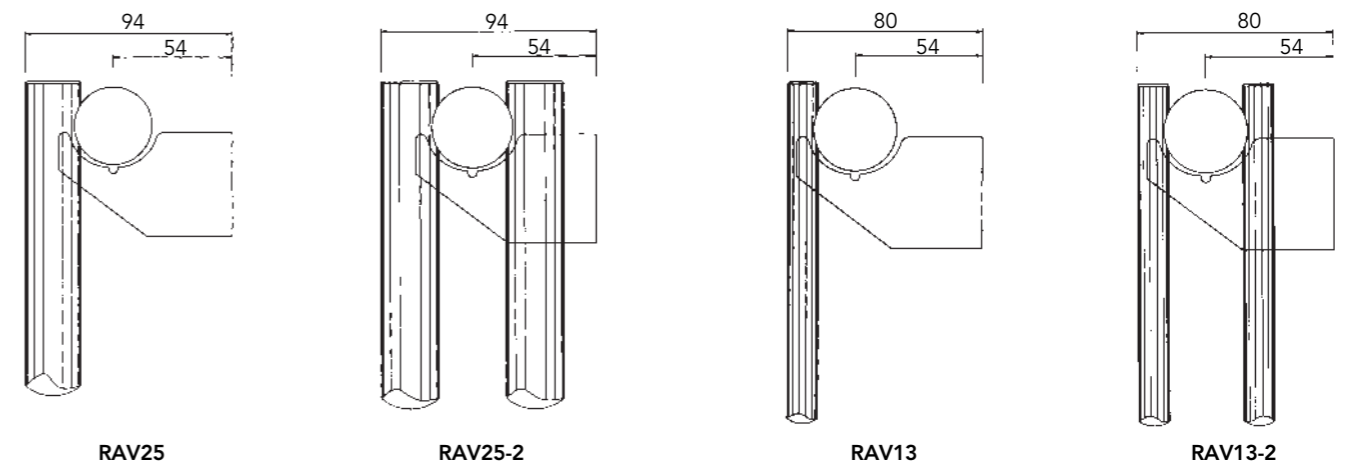

### WERKDRUK

De maximale werkdruk is 10 bar.

### HOOGTE 1400MM

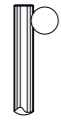

**RAV25**  
1400 x 60 mm  
0,61 L/el.  
1,09 kg/el.  
25%  
1,27



**RAV25-2**  
1400 x 80 mm  
1,17 L/el.  
2,2 kg/el.  
25%  
1,31

### HOOGTE 1600MM

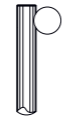

**RAV25**  
1600 x 60 mm  
0,69 L/el.  
1,23 kg/el.  
25%  
1,27



**RAV25-2**  
1600 x 80 mm  
1,33 L/el.  
2,5 kg/el.  
25%  
1,31

### HOOGTE 1800MM



**RAV25**  
1800 x 60 mm  
0,77 L/el.  
1,38 kg/el.  
25%  
1,27



**RAV25-2**  
1800 x 80 mm  
1,49 L/el.  
2,8 kg/el.  
25%  
1,31

### HOOGTE 2000MM



**RAV25**  
2000 x 60 mm  
0,85 L/el.  
1,53 kg/el.  
25%  
1,27

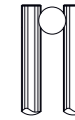

**RAV25-2**  
2000 x 80 mm  
1,65 L/el.  
3,1 kg/el.  
25%  
1,31

M = Model H x D = Hoogte x Diepte I = Inhoud G = Gewicht S = Stralingsaandeel Ex n = Exponent n

Aantal elem.	Lengte in mm	Afgifte 55/45/20	Afgifte 75/65/20	€ wit € kleur	Afgifte 55/45/20	Afgifte 75/65/20	€ wit € kleur	Afgifte 55/45/20	Afgifte 75/65/20	€ wit € kleur	Afgifte 55/45/20	Afgifte 75/65/20	€ wit € kleur
6	224	212	404	242,01 290,41	309	597	419,64 503,57	226	431	260,55 312,64	346	668	451,77 542,14
7	260	248	472	252,90 303,48	361	697	438,54 526,26	264	503	273,63 328,35	404	779	474,46 569,34
8	296	283	539	267,09 320,48	412	796	463,11 555,73	302	575	284,52 341,42	461	890	493,35 592,03
9	332	318	607	276,90 332,27	464	896	480,12 576,16	340	647	296,52 355,82	519	1002	514,15 616,98
10	368	354	674	284,52 341,42	515	995	493,35 592,03	377	719	305,24 366,28	577	1113	529,27 635,12
11	404	389	741	303,05 363,67	567	1095	525,50 630,60	415	791	325,95 391,14	634	1224	565,18 678,23
12	440	425	809	320,48 384,59	618	1194	555,73 666,88	453	863	346,66 416,00	692	1336	601,10 721,33
13	476	460	876	339,03 406,83	670	1294	587,86 705,44	491	935	367,37 440,83	749	1447	637,01 764,42
14	512	495	944	356,48 427,77	722	1393	618,12 741,74	528	1007	388,08 465,70	807	1558	672,95 807,52
15	548	531	1011	376,09 451,30	773	1493	652,16 782,57	566	1079	410,98 493,17	865	1670	712,62 855,16
16	584	566	1078	397,91 477,47	825	1592	689,94 827,95	604	1150	434,96 521,94	922	1781	754,24 905,07
17	620	602	1146	416,43 499,71	876	1692	722,09 866,50	642	1222	455,67 546,81	980	1892	790,13 948,15
18	656	637	1213	434,96 521,94	928	1791	754,24 905,07	679	1294	476,40 571,67	1038	2003	826,05 991,26
19	692	672	1281	455,67 546,81	979	1891	790,13 948,15	717	1366	497,09 596,51	1095	2115	861,97 1.034,37
20	728	708	1348	476,40 571,67	1031	1990	826,05 991,26	755	1438	517,81 621,37	1153	2226	897,88 1.077,45
22	800	778	1483	512,37 614,83	1134	2189	888,43 1.066,11	830	1582	563,59 676,31	1268	2449	977,27 1.172,71
24	872	849	1618	553,79 664,55	1237	2388	960,26 1.152,31	906	1726	605,02 726,03	1384	2671	1.049,11 1.258,93
26	944	920	1752	589,75 707,71	1340	2587	1.022,64 1.227,16	981	1869	646,44 775,73	1499	2894	1.120,94 1.345,11

M = Model H x D = Hoogte x Diepte I = Inhoud G = Gewicht S = Stralingsaandeel Ex n = Exponent n

Aantal elem.	Lengte in mm	Afgifte 55/45/20	Afgifte 75/65/20	€ wit € kleur	Afgifte 55/45/20	Afgifte 75/65/20	€ wit € kleur	Afgifte 55/45/20	Afgifte 75/65/20	€ wit € kleur	Afgifte 55/45/20	Afgifte 75/65/20	€ wit € kleur
6	224	252	481	279,07 334,89	391	755	483,91 580,70	278	530	297,60 357,14	417	806	516,04 619,25
7	260	294	561	294,34 353,21	456	881	510,36 612,44	325	618	312,86 375,44	487	940	542,50 651,01
8	296	336	641	307,42 368,89	521	1006	533,06 639,67	371	706	324,85 389,83	557	1074	563,30 675,97
9	332	378	721	318,32 381,97	586	1132	551,96 662,36	417	795	336,85 404,22	626	1209	584,09 700,91
10	368	421	801	325,95 391,14	652	1258	565,18 678,23	464	883	346,66 416,00	696	1343	601,10 721,33
11	404	463	881	348,84 418,60	717	1384	604,88 725,87	510	971	372,82 447,37	765	1477	646,46 775,76
12	440	505	961	372,82 447,37	782	1510	646,46 775,76	556	1060	397,91 477,47	835	1612	689,94 827,95
13	476	547	1041	395,71 474,86	847	1635	686,18 823,39	603	1148	424,05 508,87	904	1746	735,32 882,38
14	512	589	1121	418,60 502,33	912	1761	725,87 871,03	649	1236	450,23 540,27	974	1880	780,69 936,82
15	548	631	1202	442,60 531,11	977	1887	767,46 920,94	695	1325	476,40 571,67	1044	2015	826,05 991,26
16	584	673	1282	465,49 558,58	1043	2013	807,15 968,57	742	1413	501,46 601,74	1113	2149	869,53 1.043,43
17	620	715	1362	488,38 586,05	1108	2139	846,86 1.016,21	788	1501	527,61 633,14	1183	2283	914,89 1.097,87
18	656	757	1442	512,37 614,83	1173	2264	888,43 1.066,11	834	1589	553,79 664,55	1252	2417	960,26 1.152,31
19	692	799	1522	538,51 646,22	1238	2390	933,79 1.120,55	881	1678	579,95 695,94	1322	2552	1.005,64 1.206,74
20	728	841	1602	563,59 676,31	1303	2516	977,27 1.172,71	927	1766	605,02 726,03	1391	2686	1.049,11 1.258,93
22	800	925	1762	610,47 732,55	1434	2768	1.058,55 1.270,27	1020	1943	657,34 788,81	1530	2955	1.139,83 1.367,79
24	872	1009	1922	657,34 788,81				1113	2119	708,59 850,30			
26	944	1093	2083	703,12 843,76				1205	2296	760,91 913,09			



**ACCESSOIRES?**  
Zie pagina 202 - 207  
ACCKNOP01  
ACCREK01

**CONSOLES:**  
De Ravenna wordt standaard  
geleverd met wand-panels  
in de kleur van de radiator.

**KLEUREN:**  
De prijs wit geldt voor RAL 9016.  
De prijs kleur geldt voor de kleuren  
uit de kleurenwaaier en kleurkaart, vak

**AANSLUITINGEN:**  
(LET OP! Altijd opgeven bij bestelling)  
Beschrijving zie pagina 95.

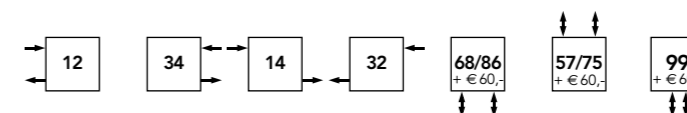

### HOOGTE 1400MM



**RAV13**  
1400 x 46 mm  
0,16 L/el.  
1,06 kg/el.  
25%  
1,26



**RAV13-2**  
1400 x 52 mm  
0,28 L/el.  
1,12 kg/el.  
25%  
1,30

### HOOGTE 1600MM



**RAV13**  
1600 x 46 mm  
0,18 L/el.  
1,07 kg/el.  
25%  
1,26



**RAV13-2**  
1600 x 52 mm  
0,32 L/el.  
1,14 kg/el.  
25%  
1,30

### HOOGTE 1800MM



**RAV13**  
1800 x 46 mm  
0,19 L/el.  
1,08 kg/el.  
25%  
1,26



**RAV13-2**  
1800 x 52 mm  
0,35 L/el.  
1,16 kg/el.  
25%  
1,30

### HOOGTE 2000MM



**RAV13**  
2000 x 46 mm  
0,21 L/el.  
1,09 kg/el.  
25%  
1,26



**RAV13-2**  
2000 x 52 mm  
0,39 L/el.  
1,17 kg/el.  
25%  
1,30

M = Model H x D = Hoogte x Diepte I = Inhoud G = Gewicht S = Stralingsaandeel Ex n = Exponent n

Aantal elem.	Lengte in mm	Afgifte 55/45/20	Afgifte 75/65/20	€ wit € kleur	Afgifte 55/45/20	Afgifte 75/65/20	€ wit € kleur	Afgifte 55/45/20	Afgifte 75/65/20	€ wit € kleur	Afgifte 55/45/20	Afgifte 75/65/20	€ wit € kleur
6	152	132	252	285,11 342,14	194	376	542,92 651,51	149	283	323,53 388,25	219	425	614,72 737,65
8	200	176	336	337,70 405,23	259	502	641,00 769,19	198	378	375,09 447,11	292	566	711,77 854,12
10	248	221	420	358,91 430,70	324	627	681,44 817,74	248	472	397,33 476,79	365	708	754,25 905,09
12	296	265	504	330,60 396,73	388	752	626,86 752,21	297	566	373,08 447,70	438	850	707,73 849,28
14	344	309	588	344,77 413,72	453	878	655,16 786,20	347	661	390,26 468,31	511	991	742,11 890,53
16	392	353	672	378,13 453,77	518	1003	717,85 861,41	396	755	424,64 509,57	585	1133	806,82 968,18
18	440	397	756	400,38 480,45	582	1129	760,31 912,38	446	850	450,93 541,11	658	1274	857,37 1.028,84
20	488	441	840	425,64 510,77	647	1254	808,84 970,61	496	944	480,25 576,30	731	1416	911,96 1.094,36
22	536	485	924	465,08 558,11	712	1379	883,66 1.060,38	545	1038	526,75 632,10	804	1558	1.000,92 1.201,12
24	584	529	1008	499,45 599,34	776	1505	948,36 1.138,02	595	1133	565,17 678,21	877	1699	1.072,72 1.287,26
26	632	573	1092	528,78 634,54	841	1630	1.004,99 1.205,98	644	1227	602,60 723,10	950	1841	1.145,52 1.374,62
28	680	617	1176	557,10 668,50	906	1756	1.058,56 1.270,28	694	1322	634,94 761,92	1023	1982	1.206,18 1.447,41
30	728	662	1260	586,40 703,68	971	1881	1.113,16 1.335,80	743	1416	666,29 799,53	1096	2124	1.266,84 1.520,20
32	776	706	1344	609,66 731,59	1035	2006	1.157,65 1.389,17	793	1510	693,59 832,30	1169	2266	1.317,39 1.580,86
34	824	750	1428	635,94 763,13	1100	2132	1.208,19 1.449,83	843	1605	722,89 867,47	1242	2407	1.374,01 1.648,82
36	872	794	1512	664,26 797,11	1165	2257	1.262,79 1.515,34	892	1699	757,27 908,72	1315	2549	1.437,70 1.725,24
38	920	838	1596	693,59 832,30	1229	2383	1.317,39 1.580,86	942	1794	792,67 951,20	1388	2690	1.506,46 1.807,74
40	968	882	1680	734,01 880,81	1294	2508	1.394,23 1.673,07	991	1888	836,13 1.003,36	1461	2832	1.589,36 1.907,24

M = Model H x D = Hoogte x Diepte I = Inhoud G = Gewicht S = Stralingsaandeel Ex n = Exponent n

Aantal elem.	Lengte in mm	Afgifte 55/45/20	Afgifte 75/65/20	€ wit € kleur	Afgifte 55/45/20	Afgifte 75/65/20	€ wit € kleur	Afgifte 55/45/20	Afgifte 75/65/20	€ wit € kleur	Afgifte 55/45/20	Afgifte 75/65/20	€ wit € kleur
6	152	165	315	350,83 421,00	244	472	665,27 798,33	182	347	375,09 450,11	268	519	711,77 854,12
8	200	221	420	401,38 481,65	325	630	762,33 914,79	243	462	423,63 508,35	357	692	804,79 965,75
10	248	276	525	428,68 514,42	406	787	814,91 977,90	303	578	449,91 539,91	446	865	855,33 1.026,41
12	296	331	630	402,39 482,87	487	944	764,34 917,23	364	694	423,63 508,35	536	1038	804,79 965,75
14	344	386	735	420,59 504,71	569	1102	798,72 958,48	425	809	448,91 538,69	625	1211	853,32 1.023,99
16	392	441	840	461,04 553,25	650	1259	875,57 1.050,67	486	925	491,36 589,65	714	1384	934,21 1.121,04
18	440	496	945	491,36 589,65	731	1417	934,21 1.121,04	546	1040	526,75 632,10	803	1557	1.000,92 1.201,12
20	488	551	1050	523,72 628,46	812	1574	994,86 1.193,84	607	1156	557,10 668,50	893	1730	1.058,56 1.270,28
22	536	606	1155	573,26 687,92	893	1731	1.088,89 1.306,67	668	1272	610,68 732,80	982	1903	1.159,66 1.391,60
24	584	662	1260	614,72 737,65	975	1889	1.167,77 1.401,31	728	1387	659,21 791,05	1071	2076	1.252,69 1.503,22
26	632	717	1365	654,15 784,97	1056	2046	1.242,57 1.491,08	789	1503	702,67 843,21	1160	2249	1.335,59 1.602,71
28	680	772	1470	688,53 826,23	1137	2204	1.309,31 1.571,16	850	1618	742,11 890,53	1250	2422	1.410,40 1.692,48
30	728	827	1575	722,89 867,47	1218	2361	1.374,01 1.648,82	910	1734	778,51 934,21	1339	2595	1.478,14 1.773,77
32	776	882	1680	759,30 911,15	1299	2518	1.441,76 1.730,11	971	1850	814,91 977,90	1428	2768	1.548,93 1.858,71
34	824	937	1785	832,09 998,50	1381	2676	1.581,28 1.897,54	1032	1965	854,33 1.025,19	1518	2941	1.623,73 1.948,49
36	872	992	1890	831,09 997,30	1462	2833	1.579,24 1.895,10	1092	2081	891,74 1.070,09	1607	3114	1.694,51 2.033,41
38	920	1047	1995	867,47 1.040,97	1543	2991	1.648,01 1.977,61	1153	2196	933,20 1.119,84	1696	3287	1.773,39 2.128,05
40	968	1103	2100	917,02 1.100,43	1624	3148	1.743,04 2.091,64	1214	2312	987,79 1.185,36	1785	3460	1.875,50 2.250,59



**ACCESSOIRES?**  
Zie pagina 202 - 207  
ACCKNOP01  
ACCREK01

**CONSOLES:**  
De Ravenna wordt standaard  
geleverd met wand-panels  
in de kleur van de radiator.

**KLEUREN:**  
De prijs wit geldt voor RAL 9016.  
De prijs kleur geldt voor de kleuren  
uit de kleurenwaaier en kleurkaart, vak

**AANSLUITINGEN:**  
(LET OP! Altijd opgeven bij bestelling)  
Beschrijving zie pagina 95.

