



## QUADRO - V

De QUADRO - V is een moderne designradiator gemaakt van recyclebaar staal. Door de fraaie vormgeving geschikt voor elke ruimte in huis. De rechthoekige buizen geven de QUADRO - V een strakke, minimalistische vormgeving. De QUADRO - V is opgebouwd uit twee ronde horizontale collectorbuizen met daarop verticale rechthoekige buizen. De rechthoekige buizen hebben een afmeting van 15mm x 20mm. De QUADRO - V is leverbaar in een enkele en een dubbele uitvoering. Het ophangmateriaal is in de kleur van de radiator en wordt samen met de ontluchting meegeleverd. De radiator wordt na een grondige roestwerende voorbehandeling voorzien van een poeder-epoxylaag.



Radiator QV 180.10k  
Kleur GRPR

## SPECIFICATIES QUADRO - V

### AANSLUITPOSITIES QUADRO VERTICAAL QV

De QV is standaard voorzien van 4 aansluitingen 1/2".  
Deze 4 aansluitingen zijn als volgt te gebruiken:

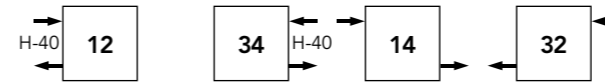

Daarnaast zijn er voor de Quadro een aantal speciale aansluitingen waarvoor een meerprijs geldt:

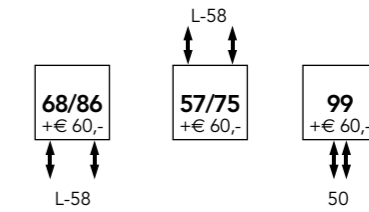

**LET OP!** De gewenste aansluitpositie dient te worden opgegeven bij bestelling!

### OPHANGING

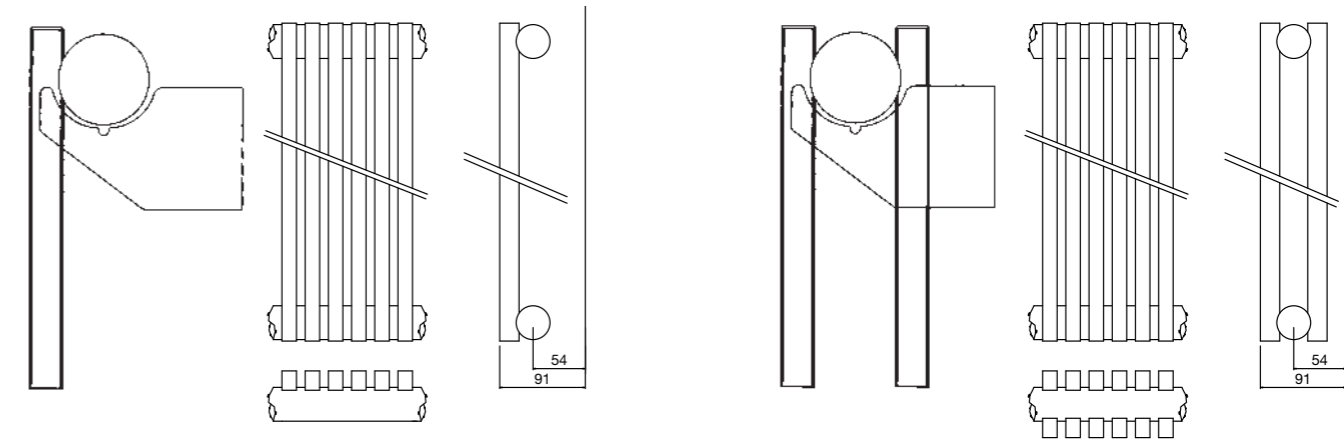

QUADRO VERTICAAL ENKEL

QUADRO VERTICAAL DUBBEL

### WERKDRUK

Maximale werkdruk is 10 bar.

### HOOGTE 600MM

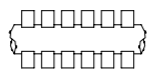
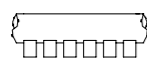

### HOOGTE 800MM

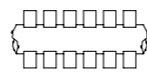
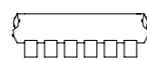

### HOOGTE 1200MM

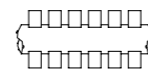
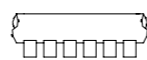

### HOOGTE 1600MM

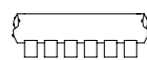

M	QV060	QV060-2	QV080	QV080-2
H	600 mm	600 mm	800 mm	800 mm
D	55 mm	74 mm	55 mm	74 mm
I	0,17 L/el.	0,31 L/el.	0,22 L/el.	0,39 L/el.
S	25%	25%	25%	25%
Ex n	1,33	1,38	1,33	1,38

M	QV120	QV120-2	QV160	QV160-2
H	1200 mm	1200 mm	1600 mm	1600 mm
D	55 mm	74 mm	55 mm	74 mm
I	0,31 L/el.	0,57 L/el.	0,39 L/el.	0,75 L/el.
S	25%	25%	25%	25%
Ex n	1,33	1,38	1,33	1,38

		M = Model			H = Hoogte	D = Diepte		I = Inhoud		S = Stralingsaandeel		Ex n = Exponent n		
Aantal elem.	Lengte in mm	Afgifte 55/45/20	Afgifte 75/65/20	€ wit € kleur	Afgifte 55/45/20	Afgifte 75/65/20	€ wit € kleur	Afgifte 55/45/20	Afgifte 75/65/20	€ wit € kleur	Afgifte 55/45/20	Afgifte 75/65/20	€ wit € kleur	
10	248	112	221	507,95 609,56	166	333	676,15 811,39	146	286	521,41 625,70	216	433	706,45 847,72	
12	296	135	265	534,89 641,85	199	400	728,29 873,97	175	343	551,69 662,03	259	520	761,94 914,34	
14	344	157	309	563,46 676,15	232	466	780,44 936,54	204	400	581,97 698,37	302	606	819,14 982,96	
16	392	180	354	581,97 698,37	265	533	819,14 982,96	233	458	602,16 722,58	345	693	862,87 1.035,44	
18	440	202	398	612,24 734,71	299	599	878,00 1.053,60	262	515	634,11 760,94	388	779	926,78 1.112,13	
20	488	225	442	642,52 771,03	332	666	936,87 1.124,25	291	572	667,75 801,30	431	866	992,37 1.190,84	
22	536	247	486	661,02 793,22	365	733	977,23 1.172,69	320	629	689,62 827,55	474	953	1.036,11 1.243,33	
24	584	270	530	691,31 829,56	398	799	1.036,11 1.243,33	349	686	723,26 867,91	518	1039	1.100,03 1.320,04	
26	632	292	575	721,58 865,90	431	866	1.094,98 1.313,98	378	744	756,90 908,27	561	1126	1.163,94 1.396,73	
28	680	315	619	777,08 932,50	464	932	1.179,07 1.414,89	408	801	814,08 976,90	604	1212	1.253,09 1.503,70	
30	728	337	663	830,91 997,08	498	999	1.263,18 1.515,81	437	858	872,96 1.047,54	647	1299	1.342,24 1.610,68	
32	776	360	707	886,42 1.063,69	531	1066	1.347,27 1.616,74	466	915	930,14 1.116,17	690	1386	1.433,05 1.719,68	
34	824	382	751	941,92 1.130,30	564	1132	1.433,05 1.719,68	495	972	989,02 1.186,81	733	1472	1.522,21 1.826,65	
36	872	405	796	997,43 1.196,91	597	1199	1.517,17 1.820,60	524	1030	1.047,89 1.257,45	776	1559	1.611,36 1.933,62	
38	920	427	840	1.052,93 1.263,51	630	1265	1.601,26 1.921,52	553	1087	1.105,07 1.326,08	819	1645	1.700,50 2.040,58	
40	968	450	884	1.108,42 1.330,11	663	1332	1.685,37 2.022,44	582	1144	1.163,94 1.396,73	863	1732	1.789,65 2.147,56	
42	1016	472	928	1.163,94 1.396,73	697	1399	1.769,46 2.123,36	611	1201	1.221,13 1.465,35	906	1819	1.880,48 2.256,57	

		M = Model			H = Hoogte	D = Diepte		I = Inhoud		S = Stralingsaandeel		Ex n = Exponent n		
Aantal elem.	Lengte in mm	Afgifte 55/45/20	Afgifte 75/65/20	€ wit € kleur	Afgifte 55/45/20	Afgifte 75/65/20	€ wit € kleur	Afgifte 55/45/20	Afgifte 75/65/20	€ wit € kleur	Afgifte 55/45/20	Afgifte 75/65/20	€ wit € kleur	
10	248	212	417	546,65 655,98	312	626	758,58 910,29	276	543	600,47 720,57	405	814	872,96 1.047,54	
12	296	255	500	581,97 698,37	374	751	827,55 993,04	332	652	645,88 775,06	486	977	963,78 1.156,54	
14	344	297	584	617,30 740,76	436	876	894,81 1.073,79	387	760	689,62 827,55	568	1140	1.054,61 1.265,53	
16	392	340	667	642,52 771,03	499	1002	945,28 1.134,35	442	869	723,26 867,91	649	1302	1.123,57 1.348,30	
18	440	382	751	681,21 817,45	561	1127	1.022,66 1.227,18	497	977	773,73 928,45	730	1465	1.226,17 1.471,42	
20	488	425	834	719,89 863,88	623	1252	1.100,03 1.320,04	553	1086	824,18 989,02	811	1628	1.328,76 1.594,53	
22	536	467	917	753,53 904,24	686	1377	1.150,48 1.380,59	608	1195	856,14 1.027,36	892	1791	1.396,06 1.675,26	
24	584	509	1001	804,00 964,79	748	1502	1.227,85 1.473,45	663	1303	906,61 1.087,92	973	1954	1.500,34 1.800,40	
26	632	552	1084	854,46 1.025,33	811	1628	1.305,24 1.566,28	719	1412	957,06 1.148,48	1054	2116	1.602,95 1.923,54	
28	680	594	1168	920,06 1.104,07	873	1753	1.404,48 1.685,37	774	1520	1.031,07 1.237,28	1135	2279	1.725,72 2.070,88	
30	728	637	1251	985,64 1.182,78	935	1878	1.505,39 1.806,46	829	1629	1.103,40 1.324,07	1216	2442	1.848,51 2.218,22	
32	776	679	1334	1.051,26 1.261,49	998	2003	1.606,31 1.927,57	884	1738	1.177,39 1.412,88	1297	2605	1.971,30 2.365,55	
34	824	722	1418	1.116,84 1.340,22	1060	2128	1.707,23 2.048,68	940	1846	1.251,41 1.501,68	1378	2768	2.095,76 2.514,92	
36	872	764	1501	1.182,44 1.418,93	1122	2254	1.806,46 2.167,76	995	1955	1.325,41 1.590,50	1459	2930	2.218,56 2.662,27	
38	920	807	1585	1.248,04 1.497,64	1185	2379	1.907,38 2.288,86	1050	2063	1.397,74 1.677,29	1540	3093	2.341,34 2.809,61	
40	968	849	1668	1.315,32 1.578,38	1247	2504	2.008,29 2.409,96	1106	2172	1.471,75 1.766,10	1621	3256	2.465,81 2.958,97	
42	1016	891	1751	1.380,91 1.657,11	1309	2629	2.107,54 2.529,05	1161	2281	1.545,75 1.854,90	1703	3419	2.588,60 3.106,32	



**ACCESSOIRES?**  
Zie pagina 202 - 207  
ACCKNOP04  
ACCREK04

**CONSOLES:**  
De Quadro wordt standaard  
geleverd met wandconsoles  
in de kleur van de radiator.

**KLEUREN:**  
De prijs wit geldt voor RAL 9016. De prijs  
kleur geldt voor de kleuren uit de kleuren-  
waaier en kleurkaart, vak



**AANSLUITINGEN:**  
(LET OP! Altijd opgeven bij bestelling)  
Beschrijving zie pagina 47.

