

# PLINT AC

De PLINT AC heeft een elegant design, is licht in gewicht en heeft een hoge warmte afgifte. Grote raampartijen in woonkamers, keukens en kantoren lenen zich bij uitstek voor deze fraaie plintradiator. Door de slimme opbouw van de modellen biedt deze radiator voor bijna iedere situatie een oplossing. Zelfs gebogen en gehoekte uitvoeringen zijn mogelijk. De PLINT AC is opgebouwd uit rechthoekige buizen van 70x11mm. Tussen de buizen bevinden zich lamellenrijen. De collectorbuizen zijn aan de uiteinden in de radiator geïntegreerd. De radiatoren zijn standaard voorzien van afdekroosters. De PLINT AC wordt na een grondige roestwerende voorbehandeling voorzien van een poeder-epoxylaag.



Radiator AC143.1600K  
Kleur Standaard wit



## TECHNISCHE GEGEVENS PLINT AC

### MODELLEN

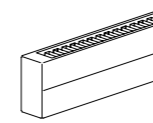

AC..2  
diepte 72mm

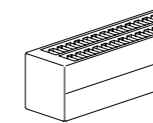

AC..3  
diepte 133mm

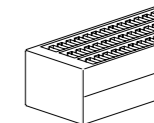

AC..4  
diepte 194mm

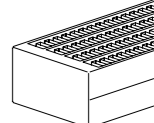

AC..5  
diepte 255mm

### AANSLUITPOSITIES (altijd opgeven bij bestelling)

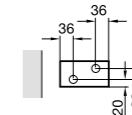
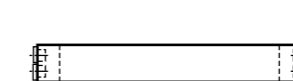

Alleen voor AC073 - AC075  
bij aansluitingen 12 en 34.  
Voor AC072 alleen 3/8" mogelijk.

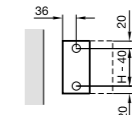
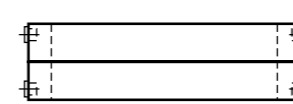
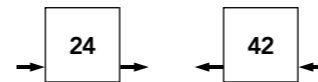

Alle overige modellen.

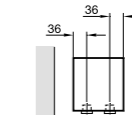
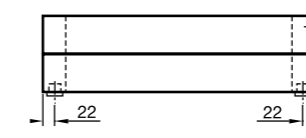
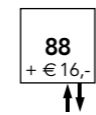
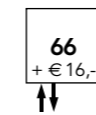
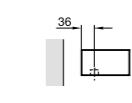
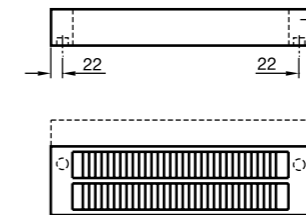
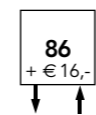
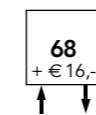
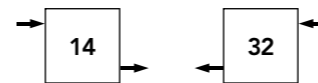

Niet mogelijk voor de modellen AC..2

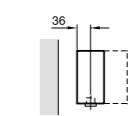
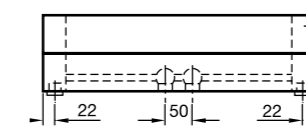
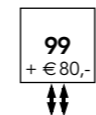

Maximale lengte van de radiator is 2 meter.

Aansluitingen voor aanvoer, retour en ontluchting zijn 1/2". Andere aansluitmaten op aanvraag. Standaard is de radiator niet voorzien van een aansluiting voor een aftap. Indien gewenst kan deze bij bestelling van de radiator worden meebesteld. Hiervoor geldt geen meerprijs.

### AFDEKROOSTER

De plintradiator AC is standaard voorzien van een afdekrooster.  
De radiator kan ook geleverd worden zonder afdekrooster.



### AFSTAND HART-TOT-WAND

Overige modellen

Model	aanvoer/retour
AC..2	≥76
AC..3	≥76
AC..4	≥76
AC..5	≥76

Uitsluitend voor modellen AC072 - AC075  
bij aansluitposities 12 en 34.

Model	aanvoer	retour
AC072	76	76
AC073	137	76
AC074	198	76
AC075	259	76

**CONSOLES** (dienen apart te worden besteld)

**Wandconsoles**

TYPE	LENGTE RADIATOR VAN TOT	AANTAL CONSOLES	MONTAGE
AC..2 / AC..3	500mm - 1300mm	2 UNIAC	
	1400mm - 2000mm	3 UNIAC	
	2200mm - 2800mm	4 UNIAC	
	3000mm - 3400mm	5 UNIAC	
	3600mm - 4000mm	6 UNIAC	
AC..4 / AC..5	500mm - 800mm	2 UNIAC	
	900mm - 1300mm	3 UNIAC	
	1400mm - 1700mm	4 UNIAC	
	1800mm - 2200mm	5 UNIAC	
	2400mm - 2600mm	6 UNIAC	
	2800mm - 3000mm	7 UNIAC	
	3200mm - 3400mm	8 UNIAC	
	3600mm - 3800mm	9 UNIAC	
	4000mm	10 UNIAC	

**Universele console UNIAC**

Te gebruiken als wand- en standconsole.  
 Lengte / hoogte 350mm, kan zelf ingekort worden.  
 UNIACW Standaard wit € 29,50  
 UNIACK Overige kleuren € 35,40

**Standconsoles**

TYPE	LENGTE RADIATOR VAN TOT	AANTAL CONSOLES	MONTAGE
AC..2 / AC..3	500mm - 2000mm	2 UNIAC	
	2200mm - 3600mm	3 UNIAC	
	3800mm - 4000mm	4 UNIAC	
AC..4 / AC..5	500mm - 2000mm	4 UNIAC	
	2200mm - 3600mm	6 UNIAC	
	3800mm - 4000mm	8 UNIAC	

**Kunststof afdekplaatje ROZETAC**

Wit kunststof afdekplaatje voor UNIAC  
 ROZETAC Standaard wit € 14,50

**Kolomvoeten**

De kolomvoeten worden geleverd als set van 2 of 3 voeten, afhankelijk van de lengte van de radiator. Kolomvoeten kunnen alleen in combinatie met de radiator besteld worden. Gebruik in combinatie met aansluitingen 68 en 86. Eén van de voeten is voorzien van een opening voor de thermostaatkop Ø58mm.

	Lengte	Prijs
FUS2	500-2000mm	€ 119,00
FUS3	2200-4000mm	€ 167,00

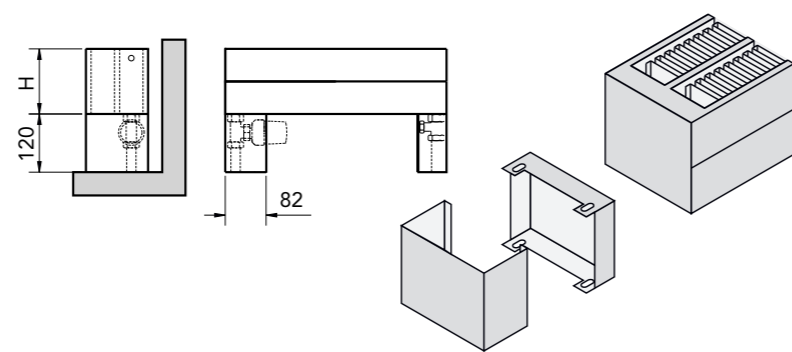

**INGEBOUWD VENTIEL**

De plinradiator AC kan, vanaf een hoogte van 140 mm, voorzien worden van een ingebouwd thermostatisch ventiel. Deze bevindt zich aan de linker- of rechterzijde van de radiator. Het ventiel is voorzien van een standaard koppeling M30x1,5. Levering is exclusief thermostaatkop. Zonder Kv voorinstelling. Aansluiting tussen laatste en een-na-laatste plaat. De meerprijs is € 97,00.

**LET OP!** Aangeven aan linker- of rechterzijde.

Links: INB.LAC  
 Rechts: INB.RAC

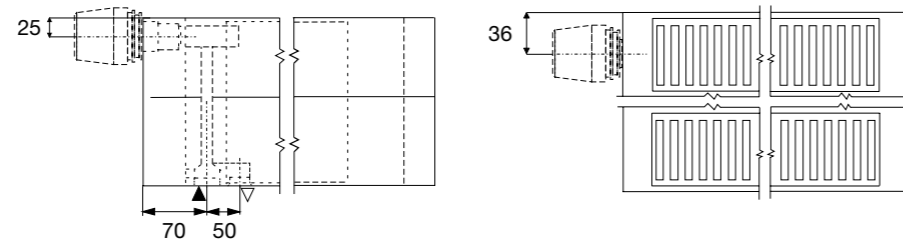

**ZITBANK**

De plinradiator AC kan ook worden uitgevoerd als zitbank of vensterbank. Hiervoor zijn speciale consoles ontwikkeld. De consoles kunnen worden geleverd in de kleur van de radiator. De bevestigingsschroeven zijn standaard verchroomd. Levering omvat uitsluitend de consoles, het zitgedeelte of vensterbank dient zelf te worden geleverd.

Type	Lengte in m.	Onder		Boven		Bevestiging	
		Aantal	Type	Aantal	Type	Aantal	Type
AC073	- 2,0	2	B232	2	B232	4	B241
	2,2 - 4,0	3		3		6	
AC074	- 2,0	2	B235	2	B235	4	B241
	2,2 - 4,0	3		3		6	
AC075	- 2,0	2	B238	2	B238	4	B241
	2,2 - 4,0	3		3		6	
AC143	- 2,0	2	B232	2	B231	4	B242
	2,2 - 4,0	3		3		6	
AC144	- 2,0	2	B235	2	B234	4	B242
	2,2 - 4,0	3		3		6	
AC145	- 2,0	2	B238	2	B237	4	B242
	2,2 - 4,0	3		3		6	

Type	Lengte in m.	Onder		Boven		Bevestiging	
		Aantal	Type	Aantal	Type	Aantal	Type
AC213	- 2,0	2	B231	2	B231	4	B243
	2,2 - 4,0	4		4		8	
AC214	- 2,0	3	B234	3	B234	6	B243
	2,2 - 4,0	5		5		10	
AC215	- 2,0	3	B237	3	B237	6	B243
	2,2 - 4,0	5		5		10	
AC283	- 2,0	2	B231	2	B231	4	B244
	2,2 - 4,0	4		4		8	
AC284	- 2,0	3	B234	3	B234	6	B244
	2,2 - 4,0	5		5		10	
AC285	- 2,0	3	B237	3	B237	6	B244
	2,2 - 4,0	5		5		10	

	B231	B232	B234	B235	B237	B238
Hoogte	110	180	110	180	110	180
Diepte	131	131	192	192	253	253
Prijs S	€ 43,67	€ 44,83	€ 45,84	€ 46,96	€ 48,06	€ 49,22
Prijs K	€ 52,40	€ 53,80	€ 55,01	€ 56,35	€ 57,67	€ 59,06

S= standaard wit, K= gekleurde uitvoering

	B241	B242	B243	B244
Prijs S	€ 3,44	€ 3,54	€ 3,63	€ 3,82

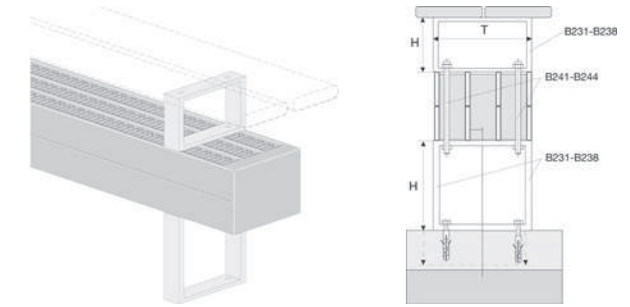

**GEBOGEN EN GEHOEKTE UITVOERINGEN** (op aanvraag)

Plinradiatoren AC zijn leverbaar in gehoekte of gebogen uitvoeringen. Deze worden op maat gemaakt aan de hand van een maatschets of een mal. Prijzen voor deze uitvoeringen zijn op aanvraag aan de hand van een maatschets.

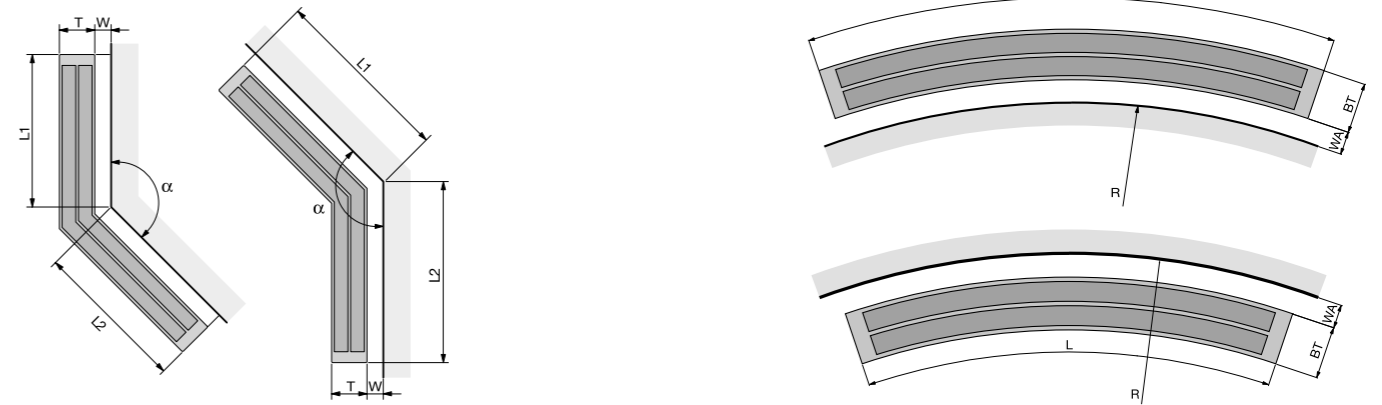

**WERKDRUK**

De standaard werkdruk van de plinradiator AC is 6 bar. Desgewenst kan deze radiator worden uitgevoerd voor een werkdruk van 10 bar. De meerprijs voor een werkdruk van 10 bar bedraagt 10% van de radiatorprijs in de kleur wit. De proefdruk is 1,3 x werkdruk.

### HOOGTE 70MM

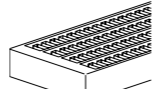
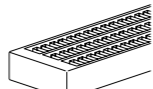
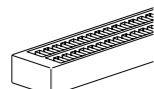
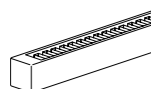

M	AC072	AC073	AC074	AC075
H x D	70 x 72 mm	70 x 133 mm	70 x 194 mm	70 x 255 mm
I	1,1 L/m	1,7 L/m	2,3 L/m	2,9 L/m
G	5,5 kg/m	9,1 kg/m	12,6 kg/m	16,1 kg/m
S	20%	10%	10%	10%
Ex n	1,24	1,22	1,22	1,21

### HOOGTE 140MM

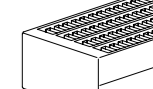
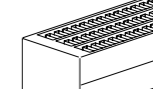
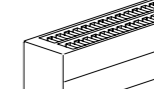
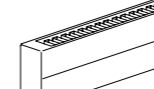

M	AC142	AC143	AC144	AC145
H x D	140 x 72 mm	140 x 133 mm	140 x 194 mm	140 x 255 mm
I	2,3 L/m	3,4 L/m	4,6 L/m	5,7 L/m
G	11 kg/m	18,7 kg/m	25,8 kg/m	33,7 kg/m
S	20%	10%	10%	10%
Ex n	1,3	1,29	1,29	1,29

Lengte in mm	M = Model			H x D = Hoogte x Diepte		I = Inhoud		G = Gewicht			S = Stralingsaandeel		Ex n = Exponent n		
	Afgifte 55/45/20	Afgifte 75/65/20	€ wit € kleur	Afgifte 55/45/20	Afgifte 75/65/20	€ wit € kleur	Afgifte 55/45/20	Afgifte 75/65/20	€ wit € kleur	Afgifte 55/45/20	Afgifte 75/65/20	€ wit € kleur	Afgifte 55/45/20	Afgifte 75/65/20	€ wit € kleur
500	93	175	197,34 236,80	160	297	273,62 328,37	219	407	350,41 420,51	278	513	427,32 512,79			
600	112	209	206,13 247,36	191	356	288,46 346,14	263	488	372,65 447,17	333	615	455,66 546,80			
700	130	244	214,94 257,92	223	415	303,28 363,93	307	569	394,86 473,82	389	718	484,01 580,81			
800	149	279	223,74 268,48	255	474	318,12 381,73	350	650	417,08 500,48	444	820	512,34 614,82			
900	167	314	232,55 279,06	287	534	332,94 399,54	394	732	439,30 527,15	500	923	540,70 648,83			
1000	186	349	241,35 289,62	319	593	347,76 417,33	438	813	461,50 553,80	555	1025	569,03 682,83			
1100	205	384	250,15 300,18	351	652	362,59 435,13	482	894	483,72 580,47	611	1128	597,36 716,85			
1200	223	419	258,97 310,76	383	712	377,43 452,92	526	976	505,94 607,14	666	1230	625,73 750,85			
1300	242	454	267,77 321,31	415	771	392,25 470,69	569	1057	528,17 633,78	722	1333	654,05 784,87			
1400	260	489	276,55 331,86	447	830	407,08 488,50	613	1138	550,37 660,43	777	1435	682,41 818,87			
1500	279	524	285,36 342,44	479	890	421,91 506,29	657	1220	572,58 687,12	833	1538	710,73 852,89			
1600	298	558	294,17 353,01	510	949	436,74 524,07	701	1301	594,81 713,77	888	1640	739,09 886,89			
1700	316	593	302,98 363,57	542	1008	451,59 541,88	745	1382	617,03 740,42	944	1743	767,41 920,90			
1800	335	628	311,79 374,15	574	1067	466,40 559,69	788	1463	639,25 767,11	999	1845	795,75 954,90			
1900	353	663	320,58 384,71	606	1127	481,23 577,49	832	1545	661,45 793,76	1055	1948	824,11 988,92			
2000	372	698	329,40 395,26	638	1186	496,05 595,27	876	1626	683,69 820,41	1110	2050	852,44 1.022,93			
2200	409	768	347,00 416,40	702	1305	525,71 630,84	964	1789	728,11 873,74	1221	2255	909,12 1.090,93			
2400	446	838	364,60 437,54	766	1423	555,37 666,43	1051	1951	772,55 927,05	1332	2460	965,81 1.158,96			
2600	484	907	382,21 458,65	829	1542	585,02 702,04	1139	2114	816,98 980,38	1443	2665	1.022,49 1.226,97			
2800	521	977	399,82 479,79	893	1660	614,67 737,63	1226	2276	861,41 1.033,70	1554	2870	1.079,15 1.295,00			
3000	558	1047	417,43 500,91	957	1779	644,34 773,20	1314	2439	905,84 1.087,02	1665	3075	1.135,84 1.363,02			
3200	595	1117	435,02 522,04	1021	1898	673,99 808,79	1402	2602	950,29 1.140,35	1776	3280	1.192,53 1.431,02			
3400	632	1187	452,64 543,19	1085	2016	703,65 844,40	1489	2764	994,71 1.193,68	1887	3485	1.249,21 1.499,06			
3600	670	1256	470,25 564,28	1148	2135	733,30 879,97	1577	2927	1.039,16 1.246,98	1998	3690	1.305,90 1.567,05			
3800	707	1326	487,85 585,43	1212	2253	762,98 915,55	1664	3089	1.083,57 1.300,30	2109	3895	1.362,57 1.635,08			
4000	744	1396	505,46 606,56	1276	2372	792,66 951,16	1752	3252	1.128,02 1.353,63	2220	4100	1.419,24 1.703,11			

Lengte in mm	M = Model			H x D = Hoogte x Diepte		I = Inhoud		G = Gewicht			S = Stralingsaandeel		Ex n = Exponent n		
	Afgifte 55/45/20	Afgifte 75/65/20	€ wit € kleur	Afgifte 55/45/20	Afgifte 75/65/20	€ wit € kleur	Afgifte 55/45/20	Afgifte 75/65/20	€ wit € kleur	Afgifte 55/45/20	Afgifte 75/65/20	€ wit € kleur	Afgifte 55/45/20	Afgifte 75/65/20	€ wit € kleur
500	141	272	267,26 320,71	228	439	370,62 444,73	308	593	479,95 575,95	386	743	602,33 722,79			
600	169	326	281,64 337,98	274	527	398,54 478,25	370	711	519,26 623,11	463	892	655,18 786,21			
700	197	380	296,04 355,24	319	615	426,46 511,75	431	830	558,56 670,26	540	1040	708,03 849,62			
800	225	434	310,42 372,52	365	702	454,38 545,26	493	948	597,86 717,44	618	1189	760,86 913,03			
900	253	489	324,83 389,78	410	790	482,33 578,79	554	1067	637,18 764,60	695	1337	813,70 976,45			
1000	281	543	339,19 407,04	456	878	510,24 612,30	616	1185	676,48 811,79	772	1486	866,56 1.039,86			
1100	309	597	353,58 424,32	502	966	538,17 645,81	678	1304	715,79 858,94	849	1635	919,40 1.103,27			
1200	337	652	368,00 441,57	547	1054	566,10 679,32	739	1422	755,09 906,11	926	1783	972,22 1.166,68			
1300	365	706	382,38 458,86	593	1141	594,02 712,83	801	1541	794,39 953,28	1004	1932	1.025,07 1.230,09			
1400	393	760	396,77 476,12	638	1229	621,94 746,35	862	1659	833,71 1.000,44	1081	2080	1.077,91 1.293,49			
1500	422	815	411,15 493,38	684	1317	649,88 779,85	924	1778	873,01 1.047,61	1158	2229	1.130,76 1.356,91			
1600	450	869	425,55 510,64	730	1405	677,82 813,37	986	1896	912,31 1.094,78	1235	2378	1.183,61 1.420,32			
1700	478	923	439,93 527,90	775	1493	705,73 846,88	1047	2015	951,63 1.141,94	1312	2526	1.236,45 1.483,72			
1800	506	977	454,33 545,20	821	1580	733,65 880,38	1109	2133	990,93 1.189,12	1390	2675	1.289,29 1.547,14			
1900	534	1032	468,73 562,47	866	1668	761,59 913,89	1170	2252	1.030,24 1.236,28	1467	2823	1.342,13 1.610,55			
2000	562	1086	483,11 579,72	912	1756	789,51 947,42	1232	2370	1.069,54 1.283,45	1544	2972	1.394,97 1.673,96			
2200	618	1195	511,88 614,28	1003	1932	845,37 1.014,43	1355	2607	1.148,15 1.377,77	1698	3269	1.500,67 1.800,79			
2400	674	1303	540,66 648,80	1094	2107	901,22 1.081,47	1478	2844	1.226,76 1.472,11	1853	3566	1.606,33 1.927,61			
2600	731	1412	569,43 683,33	1186	2283	957,06 1.148,48	1602	3081	1.305,37 1.566,46	2007	3864	1.712,03 2.054,44			
2800	787	1520	598,22 717,87	1277	2458	1.012,90 1.215,49	1725	3318	1.383,98 1.660,79	2162	4161	1.817,71 2.181,26			
3000	843	1629	627,01 752,41	1368	2634	1.068,79 1.282,53	1848	3555	1.462,60 1.755,12	2316	4458	1.923,40 2.308,08			
3200	899	1738	655,78 786,94	1459	2810	1.124,63 1.349,55	1971	3792	1.541,22 1.849,45	2470	4755	2.029,09 2.434,89			
3400	955	1846	684,58 821,48	1550	2985	1.180,47 1.416,57	2094	4029	1.619,83 1.943,79						
3600	1012	1955	713,34 856,01	1642	3161	1.236,33 1.483,61	2218	4266	1.698,44 2.038,12						
3800	1068	2063	742,12 890,54	1733	3336	1.292,18 1.550,63	2341	4503	1.777,04 2.132,46						
4000	1124	2172	770,91 925,08	1824	3512	1.348,04 1.617,64	2464	4740	1.855,66 2.226,78						



#### CONSOLES EN AFDEKROOSTERS:

Kijk voor een uitgebreide beschrijving van wandconsoles en standconsoles op pagina 140. Afdekrooster wordt standaard meegeleverd.

#### KLEUREN:

De prijs wit geldt voor RAL 9016. De prijs kleur geldt voor de kleuren uit de kleurenwaaier en kleurkaart, vak

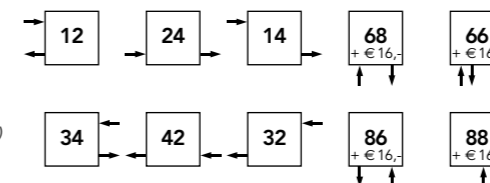

Bij aansluiting 99 is de lengte maximaal 2 meter.

#### AANSLUITINGEN:

(LET OP! Altijd opgeven bij bestelling) Beschrijving zie pagina 139.

## HOOGTE 210MM

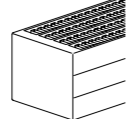
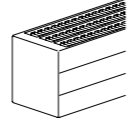
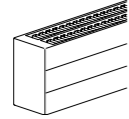
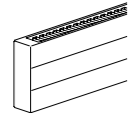

M	AC212	AC213	AC214	AC215
H x D	210 x 72 mm	210 x 133 mm	210 x 194 mm	210 x 255 mm
I	3,4 L/m	5,2 L/m	6,9 L/m	8,6 L/m
G	16,7 kg/m	28,3 kg/m	39,7 kg/m	50,9 kg/m
S	20%	10%	10%	10%
Ex n	1,35	1,37	1,35	1,36

## HOOGTE 280MM

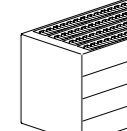
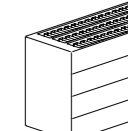
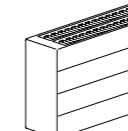
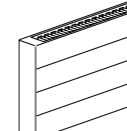

M	AC282	AC283	AC284	AC285
H x D	280 x 72 mm	280 x 133 mm	280 x 194 mm	280 x 255 mm
I	4,6 L/m	6,9 L/m	9,2 L/m	11,5 L/m
G	22,3 kg/m	37,9 kg/m	53,6 kg/m	69 kg/m
S	20%	10%	10%	10%
Ex n	1,35	1,34	1,4	1,41

M = Model			H x D = Hoogte x Diepte		I = Inhoud		G = Gewicht		S = Stralingsaandeel		Ex n = Exponent n	
Lengte in mm	Afgifte 55/45/20	Afgifte 75/65/20	€ wit € kleur	Afgifte 55/45/20	Afgifte 75/65/20	€ wit € kleur	Afgifte 55/45/20	Afgifte 75/65/20	€ wit € kleur	Afgifte 55/45/20	Afgifte 75/65/20	€ wit € kleur
500	174	346	328,47 394,16	281	564	420,57 504,68	414	820	557,91 669,49	525	1046	697,70 837,24
600	209	415	346,75 416,09	337	676	452,15 542,59	496	984	603,98 724,78	629	1255	759,13 910,96
700	244	484	365,00 438,01	393	789	483,74 580,50	579	1148	650,06 780,05	734	1464	820,58 984,69
800	278	553	383,25 459,92	450	902	515,33 618,41	662	1312	696,12 835,33	839	1674	882,02 1.058,42
900	313	622	401,53 481,82	506	1014	546,93 656,30	744	1476	742,18 890,63	944	1883	943,45 1.132,14
1000	348	691	419,77 503,73	562	1127	578,52 694,22	827	1640	788,25 945,91	1049	2092	1.004,88 1.205,88
1100	383	760	438,03 525,63	618	1240	610,13 732,13	910	1804	834,33 1.001,19	1154	2301	1.066,34 1.279,60
1200	418	829	456,30 547,54	674	1352	641,69 770,04	992	1968	880,38 1.056,47	1259	2510	1.127,78 1.353,31
1300	452	898	474,55 569,45	731	1465	673,50 807,95	1075	2132	926,46 1.111,76	1364	2720	1.189,21 1.427,05
1400	487	967	492,82 591,40	787	1578	704,90 845,87	1158	2296	972,54 1.167,06	1469	2929	1.250,65 1.500,78
1500	522	1037	511,07 613,31	843	1691	736,48 883,79	1241	2460	1.018,59 1.222,33	1574	3138	1.312,09 1.574,51
1600	557	1106	529,33 635,19	899	1803	768,07 921,70	1323	2624	1.064,67 1.277,61	1678	3347	1.373,53 1.648,23
1700	592	1175	547,59 657,10	955	1916	799,66 959,60	1406	2788	1.110,75 1.332,89	1783	3556	1.434,96 1.721,95
1800	626	1244	565,85 679,01	1012	2029	831,26 997,51	1489	2952	1.156,81 1.388,18	1888	3766	1.496,40 1.795,68
1900	661	1313	584,11 700,93	1068	2141	862,85 1.035,42	1571	3116	1.202,89 1.443,48	1993	3975	1.557,84 1.869,41
2000	696	1382	602,36 722,84	1124	2254	894,46 1.073,33	1654	3280	1.248,96 1.498,73	2098	4184	1.619,29 1.943,15
2200	766	1520	638,88 766,67	1236	2479	957,63 1.149,14	1819	3608	1.341,10 1.609,31	2308	4602	1.742,15 2.090,60
2400	835	1658	675,41 810,49	1349	2705	1.020,81 1.224,97	1985	3936	1.433,24 1.719,88			
2600	905	1797	711,92 854,31	1461	2930	1.084,00 1.300,80	2150	4264	1.525,36 1.830,44			
2800	974	1935	748,43 898,13	1574	3156	1.147,19 1.376,62	2316	4592	1.617,50 1.941,01			
3000	1044	2073	784,95 941,94	1686	3381	1.210,36 1.452,44						
3200	1114	2211	821,48 985,77	1798	3606	1.273,57 1.528,28						
3400	1183	2349	858,00 1.029,59	1911	3832	1.336,73 1.604,09						
3600	1253	2488	894,51 1.073,41	2023	4057	1.399,92 1.679,89						
3800	1322	2626	931,03 1.117,22	2136	4283	1.463,10 1.755,72						
4000	1392	2764	967,54 1.161,06	2248	4508	1.526,29 1.831,55						

M = Model			H x D = Hoogte x Diepte		I = Inhoud		G = Gewicht		S = Stralingsaandeel		Ex n = Exponent n	
Lengte in mm	Afgifte 55/45/20	Afgifte 75/65/20	€ wit € kleur	Afgifte 55/45/20	Afgifte 75/65/20	€ wit € kleur	Afgifte 55/45/20	Afgifte 75/65/20	€ wit € kleur	Afgifte 55/45/20	Afgifte 75/65/20	€ wit € kleur
500	204	405	394,16 473,00	337	682	493,85 592,60	463	942	661,75 794,09	586	1198	833,02 999,63
600	245	485	417,15 500,60	404	818	533,82 640,58	556	1130	719,75 863,71	703	1437	911,02 1.093,23
700	286	566	440,17 528,18	471	954	573,80 688,55	648	1319	777,75 933,31	820	1677	989,01 1.186,82
800	326	647	463,14 555,76	538	1090	613,77 736,53	741	1507	835,57 1.002,91	937	1916	1.067,01 1.280,41
900	367	728	486,13 583,34	606	1227	653,74 784,50	833	1696	893,78 1.072,52	1054	2156	1.144,99 1.374,00
1000	408	809	509,11 610,92	673	1363	693,71 832,45	926	1884	951,78 1.142,13	1171	2395	1.223,00 1.467,60
1100	449	890	532,10 638,50	740	1499	733,70 880,44	1019	2072	1.009,77 1.211,75	1288	2635	1.301,00 1.561,19
1200	490	971	555,08 666,09	808	1636	773,68 928,41	1111	2261	1.067,79 1.281,35	1405	2874	1.379,00 1.654,78
1300	530	1052	578,08 693,66	875	1772	813,65 976,37	1204	2449	1.125,79 1.350,97	1522	3114	1.456,99 1.748,36
1400	571	1133	601,04 721,26	942	1908	853,62 1.024,33	1296	2638	1.183,79 1.420,56	1639	3353	1.534,98 1.841,97
1500	612	1214	624,04 748,84	1010	2045	893,60 1.072,33	1389	2826	1.241,82 1.490,18	1757	3593	1.612,97 1.935,56
1600	653	1294	647,05 776,43	1077	2181	933,56 1.120,29	1482	3014	1.299,81 1.559,79	1874	3832	1.690,97 2.029,15
1700	694	1375	670,02 804,02	1144	2317	973,54 1.168,24	1574	3203	1.357,83 1.629,39			
1800	734	1456	693,01 831,60	1211	2453	1.013,52 1.216,21	1667	3391	1.415,82 1.699,01			
1900	775	1537	715,98 859,18	1279	2590	1.053,48 1.264,19	1759	3580	1.473,82 1.768,61			
2000	816	1618	738,97 886,77	1346	2726	1.093,45 1.312,14	1852	3768	1.531,86 1.838,22			
2200	898	1780	784,94 941,93	1481	2999	1.173,42 1.408,10						
2400	979	1942	830,90 997,10	1615	3271	1.253,37 1.504,02						
2600	1061	2103	876,90 1.052,27	1750	3544	1.333,30 1.599,97						
2800	1142	2265	922,86 1.107,44	1884	3816	1.413,25 1.695,90						
3000	1224	2427	968,83 1.162,60	2019	4089	1.493,20 1.791,86						
3200	1306	2589	1.014,80 1.217,77									
3400	1387	2751	1.060,77 1.272,93									
3600	1469	2912	1.106,75 1.328,12									
3800	1550	3074	1.152,71 1.383,29									
4000	1632	3236	1.198,70 1.438,45									

### CONSOLES EN AFDEKROOSTERS:

Kijk voor een uitgebreide beschrijving van wandconsoles en standconsoles op pagina 140. Afdekrooster wordt standaard meegeleverd.

### KLEUREN:

De prijs wit geldt voor RAL 9016. De prijs kleur geldt voor de kleuren uit de kleurenwaaier en kleurkaart, vak

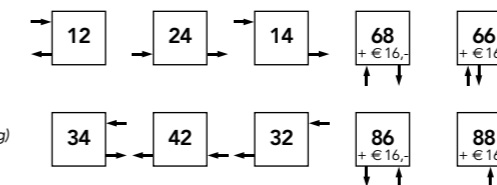

Bij aansluiting 99 is de lengte maximaal 2 meter.

### AANSLUITINGEN:

(LET OP! Altijd opgeven bij bestelling) Beschrijving zie pagina 139.