

PANEEL TV

De PANEEL TV is modern en strak vormgegeven. De radiator sluit naadloos aan bij elk interieur, want deze is leverbaar in een groot aantal verschillende afmetingen en kleuren. Het toevoegen van een functionele accessoire zoals een handdoekrek, glazen planchet of spiegel vullen het fraaie design perfect aan. De verticale panelen zijn opgebouwd uit vierkante collectorbuizen met daarop rechthoekige buizen. Deze rechthoekige buizen hebben een afmeting van 77x10mm. Tussen de buizen zit een kleine opening van 3mm dat de convectie bevordert, wat de afgifte ten goede komt. De collectorbuizen zijn zodanig achter de buizen geplaatst dat zij vanaf de voorkant niet zichtbaar zijn. Eventueel aanwezige lamellen worden door middel van puntlassen aan de elementen bevestigd. Zijbekleding wordt meegeleverd. De radiator wordt na een grondige roestwerende voorbehandeling voorzien van een poeder-epoxylaag.

TECHNISCHE GEGEVENS PANEEL TV

MODELLEN

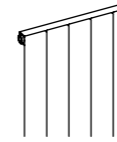

TV-10
diepte 53mm

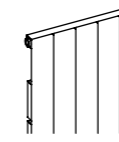

TV-11
diepte 61mm

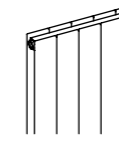

TV-20
diepte 61mm

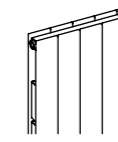

TV-21
diepte 101mm

AANSLUITPOSITIES (altijd opgeven bij bestelling)

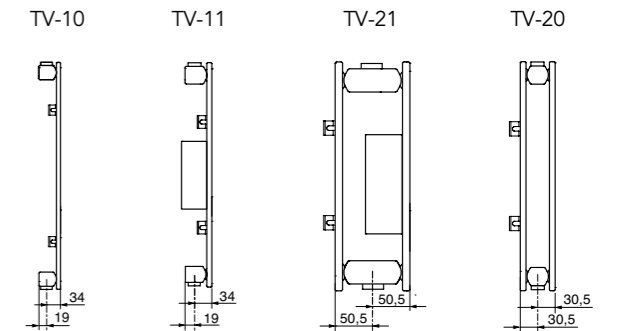
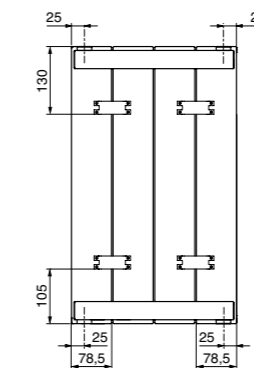
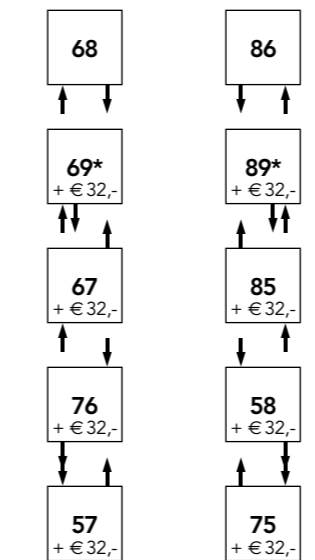
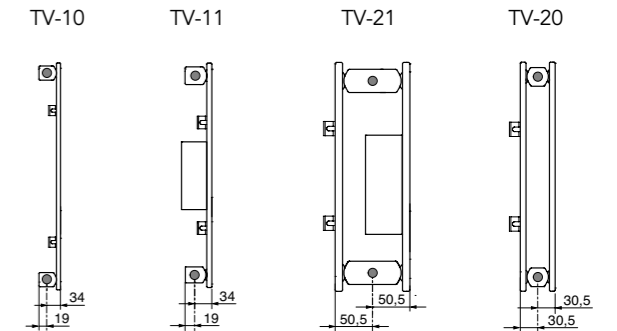
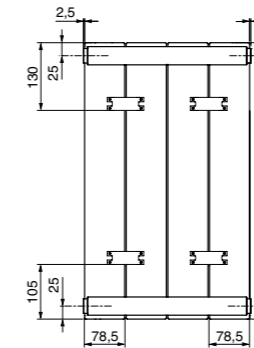
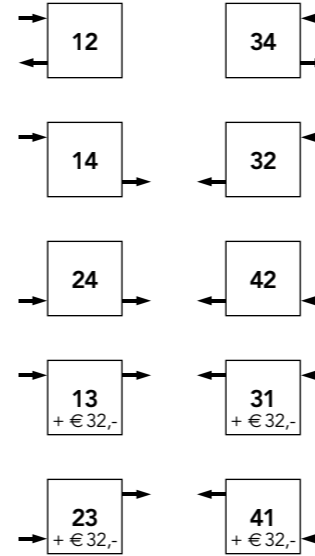

* **LET OP!** Bij aansluiting 69 en 89 is de aanvoer vanaf zijkant radiator tot hart aansluiting 53mm ipv 25mm. De retour zit op 50 mm van de aanvoer.

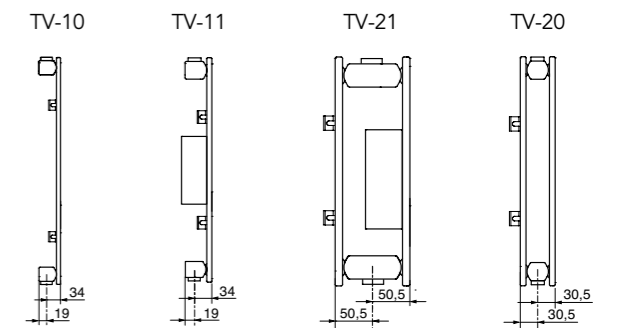
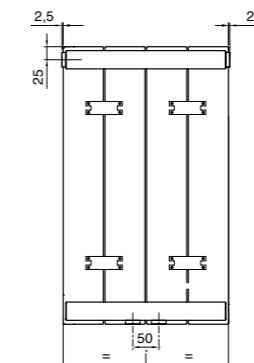
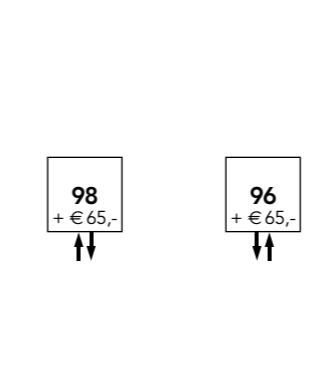

Aansluitingen voor aanvoer en retour zijn 1/2" en ontlufting is 1/4". Andere aansluitmaten op aanvraag. Standaard is de radiator niet voorzien van een aansluiting voor een aftap. Indien gewenst kan deze bij bestelling van de radiator worden meebesteld. Hiervoor geldt geen meerprijs.



Radiator TV180-11.7
Kleur Soft Zwart
Aansluitset 3DT.LI

OPHANGING

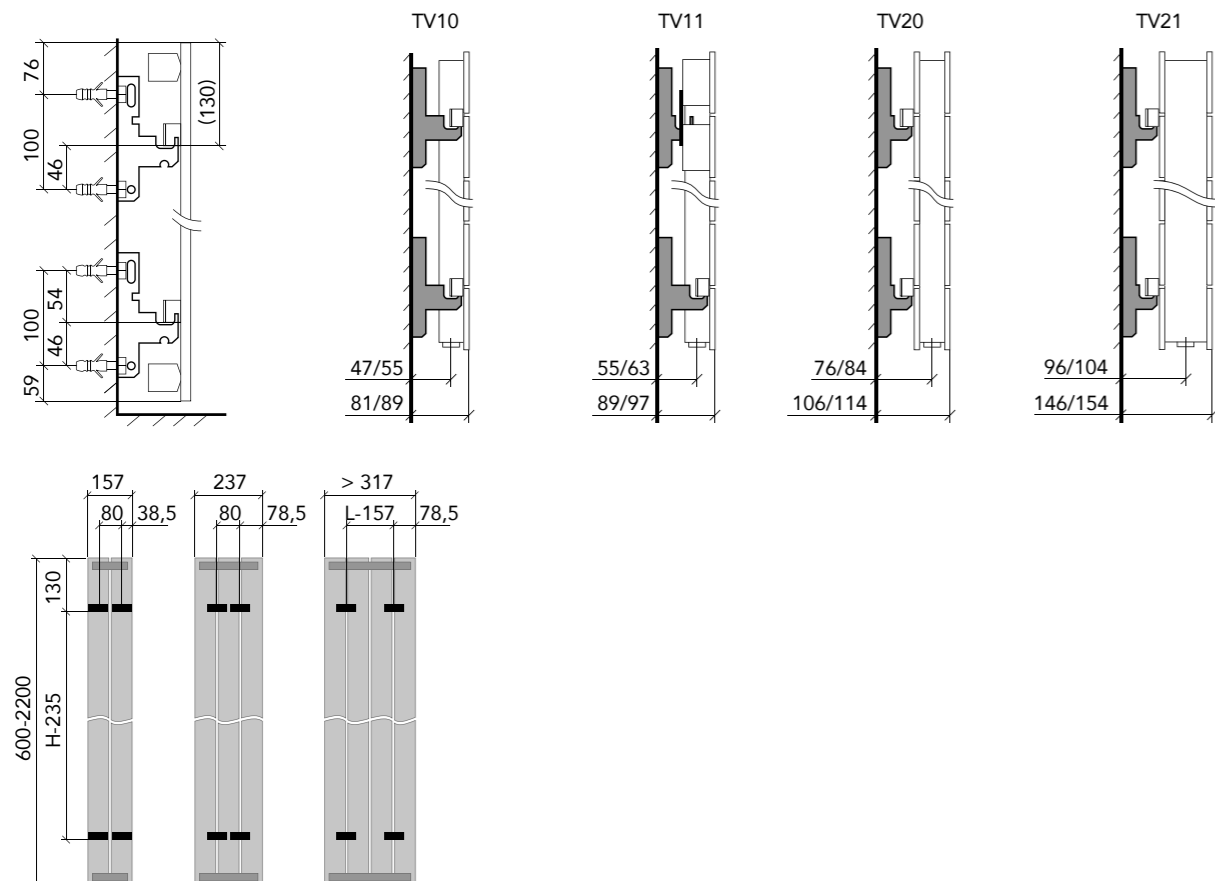

ZIJBEKLEDING

De paneelradiator TV is standaard voorzien van zijbekleding.

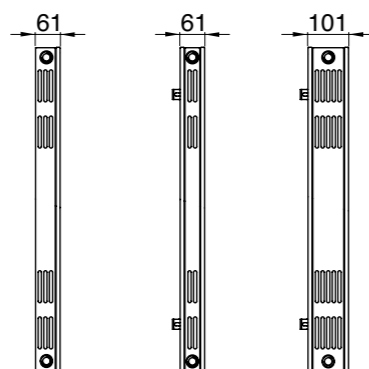

WERKDRUK

De standaard werkdruk voor de paneelradiator TV is 4 bar. Indien gewenst kunnen deze radiatoren worden uitgevoerd in een hoge druk uitvoering. Deze heeft een werkdruk van 10 bar. De meerprijs hiervoor bedraagt 10% van de prijs van de radiator in de standaardkleur wit. De proefdruk is 1,3 x de werkdruk.

CONSOLES (worden standaard meegeleverd)

Wandconsole WT

Uit gelakt staal, geleverd als set van 4 of 6 consoles. Compleet met anti-ophefbeveiliging, ringen, schroeven en pluggen.

	Standaard wit	Kleur
WT04	€ 43,20	€ 51,80
WT06	€ 56,70	€ 68,00

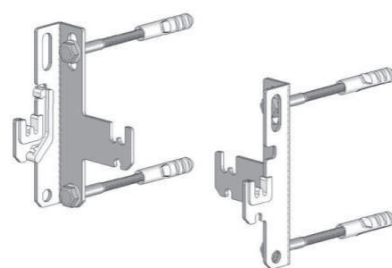

HOOGTE 600MM



M	TV060-10	TV060-11	TV060-20	TV060-21
H x D	600 x 53 mm	600 x 61 mm	600 x 61 mm	600 x 101 mm
I	0,5 L/el.	0,5 L/el.	0,8 L/el.	0,8 L/el.
G	1,4 kg/el.	1,6 kg/el.	1,6 kg/el.	2,7 kg/el.
S	50%	35%	35%	20%
Ex n	1,3	1,3	1,3	1,3

		M = Model			H x D = Hoogte x Diepte			I = Inhoud			G = Gewicht			S = Stralingsaandeel			Ex n = Exponent n		
Aantal elem.	Lengte in mm	Afgifte 55/45/20	Afgifte 75/65/20	€ wit € kleur	Afgifte 55/45/20	Afgifte 75/65/20	€ wit € kleur	Afgifte 55/45/20	Afgifte 75/65/20	€ wit € kleur	Afgifte 55/45/20	Afgifte 75/65/20	€ wit € kleur	Afgifte 55/45/20	Afgifte 75/65/20	€ wit € kleur			
2	157	78	149	250,66 300,79	90	171	262,17 314,60	104	206	332,06 398,48	133	259	461,23 553,48						
3	237	110	211	280,17 336,18	130	249	298,27 357,93	141	279	382,69 459,25	177	346	531,58 637,89						
4	317	141	271	309,66 371,59	170	324	334,40 401,27	178	352	433,34 520,01	221	432	601,92 722,32						
5	397	171	328	339,16 407,00	208	398	370,50 444,61	215	425	484,00 580,78	265	518	672,26 806,71						
6	477	200	384	368,68 442,41	246	471	406,63 487,94	252	498	534,63 641,57	309	605	742,63 891,13						
7	557	228	438	398,19 477,81	284	543	442,73 531,27	289	571	585,27 702,33	352	691	812,96 975,54						
8	637	256	492	427,68 513,22	320	614	478,84 574,60	325	644	635,93 763,10	396	778	883,30 1.059,97						
9	717	283	544	457,18 548,63	357	685	514,94 617,93	362	717	686,56 823,86	439	864	953,64 1.144,38						
10	797	310	596	486,70 584,04	393	755	551,06 661,27	399	790	737,21 884,65	482	951	1.023,99 1.228,79						
11	877	336	647	516,20 619,44	429	825	587,17 704,62	436	863	787,86 945,42	525	1037	1.094,33 1.313,21						
12	957	362	697	545,72 654,85	464	893	623,29 747,94	473	936	838,50 1.006,18	569	1124	1.164,68 1.397,62						
13	1037	388	747	575,22 690,27	499	961	659,39 791,29	510	1009	889,13 1.066,96	611	1210	1.235,02 1.482,03						
14	1117	414	796	604,72 725,67	534	1029	695,51 834,61	547	1082	939,79 1.127,76	654	1297	1.305,38 1.566,46						
15	1197	439	845	634,23 761,06	569	1097	731,63 877,96	584	1155	990,42 1.188,50	697	1383	1.375,72 1.650,85						
16	1277	464	893	663,74 796,48	603	1164	767,74 921,28	620	1228	1.041,06 1.249,28	740	1470	1.446,06 1.735,27						
17	1357	489	941	693,23 831,88	638	1231	803,84 964,62	657	1301	1.091,72 1.310,05	783	1557	1.516,40 1.819,68						
18	1437	515	990	722,74 867,29	673	1298	839,95 1.007,95	694	1374	1.142,36 1.370,83	827	1644	1.586,78 1.904,11						
19	1517	541	1040	752,24 902,71	707	1364	876,07 1.051,27	731	1446	1.193,00 1.431,59	870	1730	1.657,11 1.988,52						
20	1597	567	1090	781,76 938,10	741	1430	912,17 1.094,60	767	1518	1.243,65 1.492,37	914	1816	1.727,45 2.072,94						

AANSLUITINGEN:

(LET OP! Altijd opgeven bij bestelling)
Beschrijving zie pagina 115.

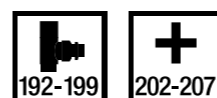
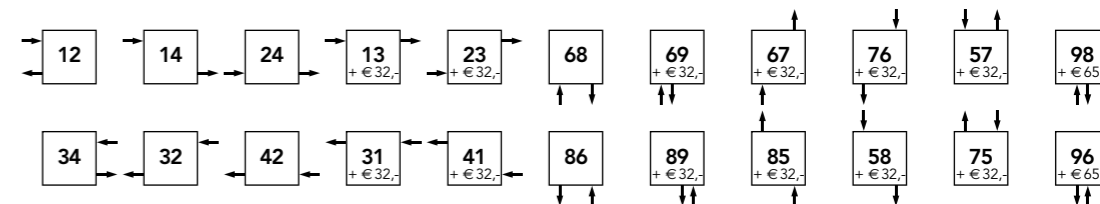

ACCESSOIRES?

Zie pagina 202 - 207
ACCKNOP02 ACCREK02
ACCKNOP08 ACCREK08

CONSOLES EN ZIJBEKLEDING:

Alle radiatoren zijn standaard voorzien van consoles en zijbekleding.

KLEUREN:

De prijs wit geldt voor RAL 9016.
De prijs kleur geldt voor de kleuren uit de kleurenwaaier en kleurkaart, vak

HOOGTE 800MM

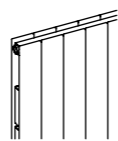
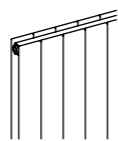
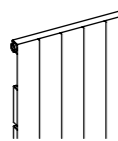
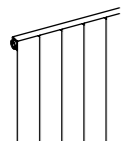

M	TV080-10	TV080-11	TV080-20	TV080-21
H x D	800 x 53 mm	800 x 61 mm	800 x 61 mm	800 x 101 mm
I	0,6 L/el.	0,6 L/el.	0,9 L/el.	1,1 L/el.
G	1,8 kg/el.	2,4 kg/el.	3,3 kg/el.	3,7 kg/el.
S	50%	35%	35%	20%
Ex n	1,3	1,3	1,3	1,3

HOOGTE 1000MM

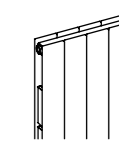
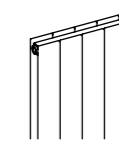
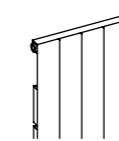
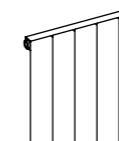

M	TV100-10	TV100-11	TV100-20	TV100-21
H x D	1000 x 53 mm	1000 x 61 mm	1000 x 61 mm	1000 x 101 mm
I	0,7 L/el.	0,7 L/el.	1,1 L/el.	1,3 L/el.
G	2,2 kg/el.	2,9 kg/el.	4,1 kg/el.	4,8 kg/el.
S	50%	35%	35%	20%
Ex n	1,3	1,3	1,3	1,3

M = Model		H x D = Hoogte x Diepte		I = Inhoud		G = Gewicht		S = Stralingsaandeel		Ex n = Exponent n			
Aantal elem.	Lengte in mm	Afgifte 55/45/20	Afgifte 75/65/20	€ wit € kleur	Afgifte 55/45/20	Afgifte 75/65/20	€ wit € kleur	Afgifte 55/45/20	Afgifte 75/65/20	€ wit € kleur	Afgifte 55/45/20	Afgifte 75/65/20	€ wit € kleur
2	157	97	188	260,07 312,11	116	222	280,35 336,43	129	256	342,95 411,53	170	333	476,35 571,61
3	237	137	267	293,19 351,84	168	323	321,94 386,33	179	355	398,23 477,89	232	455	553,14 663,76
4	317	176	342	326,30 391,53	219	421	363,52 436,22	229	454	453,52 544,21	293	576	629,92 755,91
5	397	213	414	359,40 431,28	269	517	405,11 486,13	279	553	508,80 610,55	354	698	706,71 848,04
6	477	250	485	392,51 470,99	318	612	446,66 536,02	328	651	564,07 676,88	416	820	783,50 940,21
7	557	286	554	425,60 510,72	366	705	488,26 585,90	378	750	619,36 743,23	477	941	860,29 1.032,34
8	637	321	621	458,69 550,42	413	797	529,84 635,81	428	849	674,64 809,56	538	1063	937,08 1.124,49
9	717	356	687	491,80 590,17	460	889	571,42 685,70	477	948	729,93 875,91	598	1184	1.013,86 1.216,64
10	797	390	753	524,90 629,88	506	979	613,01 735,62	527	1046	785,21 942,22	659	1306	1.090,67 1.308,79
11	877	424	817	557,99 669,59	552	1069	654,58 785,49	576	1145	840,47 1.008,58	719	1427	1.167,44 1.400,93
12	957	457	881	591,11 709,33	598	1159	696,16 835,40	626	1244	895,77 1.074,92	779	1549	1.244,23 1.493,08
13	1037	490	943	624,20 749,04	643	1247	737,74 885,30	675	1342	951,04 1.141,25	839	1670	1.321,01 1.585,22
14	1117	523	1006	657,31 788,77	688	1335	779,32 935,19	724	1441	1.006,33 1.207,58	899	1792	1.397,81 1.677,38
15	1197	556	1067	690,42 828,50	732	1423	820,92 985,09	774	1540	1.061,62 1.273,93	959	1914	1.474,61 1.769,52
16	1277	588	1128	723,50 868,21	776	1510	862,48 1.034,98	823	1639	1.116,90 1.340,26	1019	2035	1.551,39 1.861,67
17	1357	620	1189	756,62 907,93	821	1597	904,07 1.084,87	873	1738	1.172,17 1.406,61	1079	2156	1.628,17 1.953,82
18	1437	652	1250	789,71 947,66	866	1684	945,65 1.134,78	923	1837	1.227,46 1.472,94	1140	2277	1.704,98 2.045,96
19	1517	684	1311	822,83 987,38	910	1770	987,22 1.184,68	972	1935	1.282,75 1.539,28	1200	2397	1.781,75 2.138,10
20	1597	715	1372	855,91 1.027,11	954	1856	1.028,79 1.234,57	1021	2033	1.338,02 1.605,61	1260	2517	1.858,54 2.230,25

M = Model		H x D = Hoogte x Diepte		I = Inhoud		G = Gewicht		S = Stralingsaandeel		Ex n = Exponent n			
Aantal elem.	Lengte in mm	Afgifte 55/45/20	Afgifte 75/65/20	€ wit € kleur	Afgifte 55/45/20	Afgifte 75/65/20	€ wit € kleur	Afgifte 55/45/20	Afgifte 75/65/20	€ wit € kleur	Afgifte 55/45/20	Afgifte 75/65/20	€ wit € kleur
2	157	115	227	269,35 323,20	141	272	298,49 358,18	156	309	353,94 424,73	205	405	491,64 589,96
3	237	164	322	305,96 367,14	205	395	345,55 414,67	218	432	413,94 496,72	283	559	574,98 689,98
4	317	210	413	342,57 411,09	266	514	392,62 471,14	279	555	473,93 568,70	361	713	658,31 790,00
5	397	256	501	379,19 455,03	327	632	439,69 527,62	341	678	533,90 640,70	437	866	741,66 889,99
6	477	300	586	415,82 498,97	385	747	486,76 584,11	403	801	593,90 712,68	514	1020	824,99 989,99
7	557	343	669	452,43 542,91	444	861	533,82 640,58	464	924	653,88 784,65	591	1174	908,35 1.090,00
8	637	386	750	489,05 586,86	501	974	580,88 697,06	526	1047	713,89 856,65	668	1328	991,67 1.190,01
9	717	428	830	525,69 630,81	558	1086	627,95 753,54	588	1171	773,87 928,66	745	1482	1.075,00 1.290,00
10	797	469	909	562,30 674,74	615	1197	675,03 810,04	649	1294	833,87 1.000,65	821	1636	1.158,36 1.390,02
11	877	511	987	598,90 718,69	670	1307	722,10 866,52	710	1417	893,85 1.072,64	897	1790	1.241,68 1.490,02
12	957	552	1064	635,52 762,64	725	1415	769,17 923,00	771	1540	953,84 1.144,61	973	1944	1.325,02 1.590,02
13	1037	592	1139	672,14 806,56	780	1524	816,24 979,48	832	1663	1.013,84 1.216,60	1049	2098	1.408,36 1.690,02
14	1117	633	1215	708,77 850,52	835	1632	863,29 1.035,96	893	1786	1.073,83 1.288,59	1124	2252	1.491,71 1.790,04
15	1197	673	1289	745,38 894,48	888	1739	910,36 1.092,44	954	1909	1.133,81 1.360,57	1200	2406	1.575,04 1.890,04
16	1277	712	1362	782,00 938,41	941	1846	957,42 1.148,91	1015	2032	1.193,80 1.432,56	1275	2560	1.658,37 1.990,05
17	1357	752	1435	818,62 982,36	996	1953	1.004,50 1.205,41	1077	2155	1.253,79 1.504,54	1352	2714	1.741,71 2.090,07
18	1437	790	1507	855,26 1.026,28	1050	2060	1.051,56 1.261,90	1138	2278	1.313,77 1.576,53	1428	2868	1.825,06 2.190,07
19	1517	828	1579	891,85 1.070,23	1104	2166	1.098,64 1.318,36	1199	2400	1.373,78 1.648,52	1504	3021	1.908,39 2.290,06
20	1597	865	1651	928,48 1.114,18	1158	2272	1.145,70 1.374,85	1260	2522	1.433,76 1.720,52	1581	3174	1.991,73 2.390,07



ACCESSOIRES?

Zie pagina 202 - 207
ACCKNOPO2 ACCREK02
ACCKNOP08 ACCREK08

CONSOLES EN ZIJBEKLEDING:

Alle radiatoren zijn standaard voorzien van consoles en zijbekleding.

KLEUREN:

De prijs wit geldt voor RAL 9016.
De prijs kleur geldt voor de kleuren uit de kleurenwaaier en kleurkaart, vak



AANSLUITINGEN:

(LET OP! Altijd opgeven bij bestelling)
Beschrijving zie pagina 115.

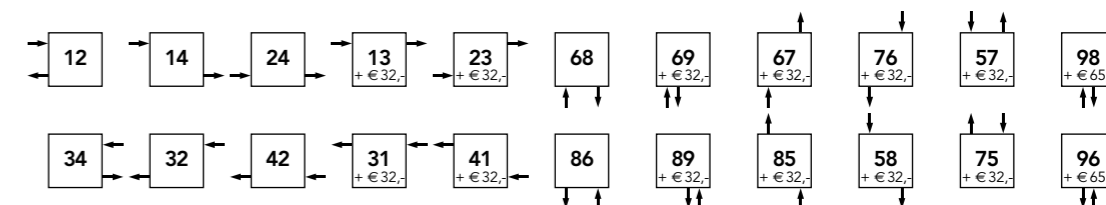

HOOGTE 1200MM

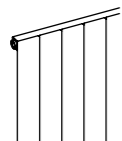

M	TV120-10	TV120-11	TV120-20	TV120-21
H x D	1200 x 53 mm	1200 x 61 mm	1200 x 61 mm	1200 x 101 mm
I	0,8 L/el.	0,8 L/el.	1,2 L/el.	1,5 L/el.
G	2,6 kg/el.	3,5 kg/el.	4,8 kg/el.	5,7 kg/el.
S	50%	35%	35%	20%
Ex n	1,3	1,3	1,3	1,3

HOOGTE 1400MM

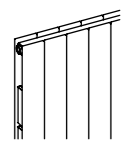
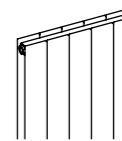
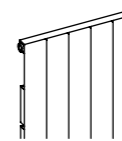
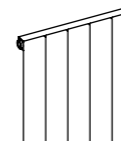

M	TV140-10	TV140-11	TV140-20	TV140-21
H x D	1400 x 53 mm	1400 x 61 mm	1400 x 61 mm	1400 x 101 mm
I	0,9 L/el.	0,9 L/el.	1,3 L/el.	1,7 L/el.
G	3 kg/el.	4,2 kg/el.	5,6 kg/el.	6,8 kg/el.
S	50%	35%	35%	20%
Ex n	1,3	1,3	1,3	1,3

M = Model		H x D = Hoogte x Diepte			I = Inhoud		G = Gewicht		S = Stralingsaandeel		Ex n = Exponent n		
Aantal elem.	Lengte in mm	Afgifte 55/45/20	Afgifte 75/65/20	€ wit € kleur	Afgifte 55/45/20	Afgifte 75/65/20	€ wit € kleur	Afgifte 55/45/20	Afgifte 75/65/20	€ wit € kleur	Afgifte 55/45/20	Afgifte 75/65/20	€ wit € kleur
2	157	130	258	278,59 334,30	165	319	316,59 379,90	183	363	366,87 440,23	240	474	509,50 611,43
3	237	188	371	318,72 382,49	239	464	369,06 442,87	256	509	431,75 518,08	333	658	599,62 719,54
4	317	243	480	358,88 430,68	312	605	421,52 505,84	329	655	496,62 595,93	426	842	689,72 827,67
5	397	297	585	399,05 478,86	382	743	473,99 568,79	402	802	561,48 673,80	518	1026	779,81 935,78
6	477	351	689	439,18 527,04	452	879	526,46 631,75	475	948	626,36 751,65	609	1209	869,91 1.043,90
7	557	403	790	479,35 575,22	520	1013	578,92 694,72	548	1094	691,24 829,49	701	1393	960,01 1.152,02
8	637	456	891	519,50 623,41	587	1146	631,39 757,67	621	1240	756,12 907,34	792	1577	1.050,12 1.260,14
9	717	507	989	559,67 671,58	653	1277	683,86 820,63	694	1387	820,99 985,20	883	1761	1.140,22 1.368,27
10	797	559	1087	599,81 719,76	719	1407	736,33 883,59	766	1533	885,88 1.063,05	974	1945	1.230,32 1.476,38
11	877	610	1183	639,95 767,94	783	1536	788,79 946,55	838	1679	950,75 1.140,89	1065	2129	1.320,42 1.584,52
12	957	661	1279	680,11 816,14	848	1665	841,26 1.009,52	910	1825	1.015,62 1.218,76	1155	2313	1.410,52 1.692,63
13	1037	712	1374	720,25 864,31	911	1792	893,72 1.072,49	983	1972	1.080,50 1.296,58	1245	2496	1.500,61 1.800,74
14	1117	761	1467	760,42 912,50	974	1919	946,19 1.135,42	1055	2118	1.145,36 1.374,45	1335	2680	1.590,72 1.908,87
15	1197	812	1561	800,55 960,69	1037	2045	998,66 1.198,38	1127	2264	1.210,24 1.452,30	1424	2864	1.680,82 2.016,99
16	1277	862	1653	840,71 1.008,87	1099	2170	1.051,12 1.261,35	1199	2411	1.275,13 1.530,15	1513	3048	1.770,92 2.125,10
17	1357	910	1745	880,87 1.057,04	1162	2295	1.103,60 1.324,31	1272	2558	1.340,00 1.608,01	1605	3232	1.861,03 2.233,23
18	1437	958	1837	921,01 1.105,22	1225	2420	1.156,07 1.387,28	1345	2705	1.404,87 1.685,85	1696	3416	1.951,13 2.341,34
19	1517	1005	1928	961,18 1.153,41	1288	2544	1.208,52 1.450,23	1417	2851	1.469,76 1.763,70	1787	3599	2.041,21 2.449,47
20	1597	1053	2019	1.001,32 1.201,59	1351	2668	1.261,01 1.513,19	1490	2997	1.534,63 1.841,55	1878	3782	2.131,33 2.557,59

M = Model		H x D = Hoogte x Diepte			I = Inhoud		G = Gewicht		S = Stralingsaandeel		Ex n = Exponent n		
Aantal elem.	Lengte in mm	Afgifte 55/45/20	Afgifte 75/65/20	€ wit € kleur	Afgifte 55/45/20	Afgifte 75/65/20	€ wit € kleur	Afgifte 55/45/20	Afgifte 75/65/20	€ wit € kleur	Afgifte 55/45/20	Afgifte 75/65/20	€ wit € kleur
2	157	150	297	288,08 345,68	189	366	334,79 401,74	210	418	382,60 459,10	276	542	531,38 637,66
3	237	216	427	331,82 398,19	273	531	392,75 471,31	294	587	452,17 542,60	383	753	628,03 753,63
4	317	279	551	375,58 450,68	356	693	450,70 540,82	378	755	521,76 626,10	490	965	724,69 869,61
5	397	342	673	419,30 503,17	437	851	508,66 610,38	461	923	591,33 709,61	596	1177	821,34 985,58
6	477	403	792	463,07 555,66	516	1007	566,61 679,93	545	1092	660,93 793,10	702	1388	917,98 1.101,57
7	557	463	909	506,82 608,18	593	1160	624,57 749,47	629	1260	730,49 876,60	808	1600	1.014,63 1.217,55
8	637	523	1024	550,55 660,68	670	1312	682,52 819,01	712	1428	800,08 960,11	913	1812	1.111,29 1.333,54
9	717	581	1137	594,30 713,17	745	1462	740,48 888,56	795	1596	869,66 1.043,60	1017	2023	1.207,93 1.449,52
10	797	639	1249	638,07 765,67	820	1611	798,43 956,77	878	1765	939,26 1.127,11	1122	2235	1.304,58 1.565,49
11	877	697	1360	681,81 818,16	894	1759	856,40 1.027,66	961	1933	1.008,82 1.210,60	1226	2447	1.401,22 1.681,46
12	957	755	1470	725,55 870,66	967	1907	914,32 1.097,18	1044	2101	1.078,41 1.294,10	1329	2658	1.497,88 1.797,45
13	1037	812	1579	769,30 923,16	1039	2052	972,29 1.166,74	1127	2270	1.148,00 1.377,61	1432	2870	1.594,54 1.913,43
14	1117	869	1687	813,06 975,67	1111	2197	1.030,26 1.236,29	1209	2438	1.217,59 1.461,10	1535	3082	1.691,18 2.029,41
15	1197	926	1794	856,80 1.028,15	1181	2341	1.088,20 1.305,84	1291	2606	1.287,18 1.544,62	1637	3293	1.787,83 2.145,39
16	1277	982	1900	900,54 1.080,65	1251	2484	1.146,17 1.375,38	1374	2775	1.356,76 1.628,11	1739	3505	1.884,49 2.261,38
17	1357	1035	2006	944,29 1.133,16	1323	2627	1.204,09 1.444,92	1457	2944	1.426,34 1.711,62	1844	3717	1.981,13 2.377,35
18	1437	1090	2112	988,06 1.185,63	1395	2770	1.262,05 1.514,48	1541	3113	1.495,93 1.795,10	1949	3929	2.077,78 2.493,34
19	1517	1149	2216	1.031,79 1.238,14	1467	2912	1.320,00 1.584,02	1624	3281	1.565,51 1.878,61			
20	1597	1203	2320	1.075,54 1.290,66	1539	3054	1.377,96 1.653,56	1707	3449	1.635,09 1.962,12			



ACCESSOIRES?

Zie pagina 202 - 207
ACCKNOPO2 ACCREK02
ACCKNOP08 ACCREK08

CONSOLES EN ZIJBEKLEDING:

Alle radiatoren zijn standaard voorzien van consoles en zijbekleding.

KLEUREN:

De prijs wit geldt voor RAL 9016.
De prijs kleur geldt voor de kleuren uit de kleurenwaai en kleurkaart, vak



AANSLUITINGEN:

(LET OP! Altijd opgeven bij bestelling)
Beschrijving zie pagina 115.

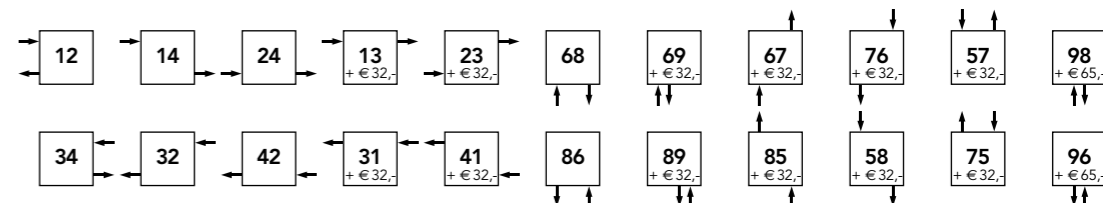

HOOGTE 1600MM

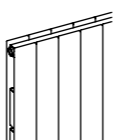
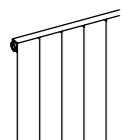

M	TV160-10	TV160-11	TV160-20	TV160-21
H x D	1600 x 53 mm	1600 x 61 mm	1600 x 61 mm	1600 x 101 mm
I	1 L/el.	1 L/el.	1,4 L/el.	1,6 L/el.
G	3,3 kg/el.	4,8 kg/el.	6,3 kg/el.	7,8 kg/el.
S	50%	35%	35%	20%
Ex n	1,3	1,3	1,3	1,3

HOOGTE 1800MM

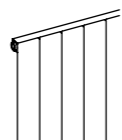

M	TV180-10	TV180-11	TV180-20	TV180-21
H x D	1800 x 53 mm	1800 x 61 mm	1800 x 61 mm	1800 x 101 mm
I	1,1 L/el.	1,1 L/el.	1,6 L/el.	1,8 L/el.
G	3,7 kg/el.	5,3 kg/el.	7,1 kg/el.	8,7 kg/el.
S	50%	35%	35%	20%
Ex n	1,3	1,3	1,3	1,3

M = Model		H x D = Hoogte x Diepte			I = Inhoud		G = Gewicht		S = Stralingsaandeel		Ex n = Exponent n		
Aantal elem.	Lengte in mm	Afgifte 55/45/20	Afgifte 75/65/20	€ wit € kleur	Afgifte 55/45/20	Afgifte 75/65/20	€ wit € kleur	Afgifte 55/45/20	Afgifte 75/65/20	€ wit € kleur	Afgifte 55/45/20	Afgifte 75/65/20	€ wit € kleur
2	157	170	336	297,43 356,91	212	411	340,31 408,37	237	475	401,41 481,70	312	609	557,51 669,01
3	237	245	483	344,72 413,67	307	597	401,36 481,62	331	664	477,27 572,72	433	846	662,85 795,41
4	317	316	624	392,04 470,43	399	778	462,39 554,88	426	854	553,12 663,75	553	1084	768,18 921,83
5	397	387	762	439,32 527,19	490	956	523,44 628,15	519	1043	628,96 754,76	673	1322	873,54 1.048,24
6	477	455	897	486,62 583,93	578	1131	584,48 701,38	613	1232	704,82 845,77	792	1559	978,89 1.174,65
7	557	523	1029	533,90 640,70	665	1303	645,54 774,64	707	1422	780,67 936,80	910	1797	1.084,22 1.301,05
8	637	590	1159	581,21 697,45	750	1474	706,59 847,89	800	1611	856,50 1.027,83	1028	2034	1.189,55 1.427,46
9	717	656	1288	628,52 754,20	835	1643	767,62 921,15	894	1801	932,38 1.118,85	1145	2272	1.294,89 1.553,88
10	797	721	1414	675,80 810,95	918	1810	828,68 994,40	986	1990	1.008,23 1.209,87	1262	2509	1.400,23 1.680,29
11	877	786	1540	723,10 867,72	1000	1976	889,71 1.067,65	1079	2179	1.084,08 1.300,89	1378	2747	1.505,58 1.806,69
12	957	850	1664	770,40 924,48	1082	2142	950,76 1.140,92	1172	2369	1.159,92 1.391,91	1494	2985	1.610,91 1.933,10
13	1037	914	1788	817,69 981,23	1163	2306	1.011,80 1.214,17	1265	2558	1.235,77 1.482,92	1609	3222	1.716,25 2.059,52
14	1117	977	1910	865,00 1.037,98	1242	2468	1.072,84 1.287,42	1357	2747	1.311,63 1.573,94	1724	3460	1.821,58 2.185,93
15	1197	1040	2031	912,30 1.094,75	1321	2630	1.133,90 1.360,68	1449	2937	1.387,48 1.664,96	1837	3697	1.926,94 2.312,35
16	1277	1103	2152	959,59 1.151,51	1399	2792	1.194,95 1.433,95	1541	3126	1.463,32 1.755,99	1951	3935	2.032,29 2.438,74
17	1357	1173	2273	1.006,88 1.208,27	1481	2954	1.255,98 1.507,18	1624	3295	1.539,18 1.847,02			
18	1437	1235	2394	1.054,19 1.265,03	1562	3116	1.317,03 1.580,44	1708	3464	1.615,03 1.938,03			
19	1517	1297	2514	1.101,48 1.321,78	1643	3277	1.378,07 1.653,70	1790	3632	1.690,88 2.029,04			
20	1597	1359	2634	1.148,78 1.378,53	1723	3438	1.439,12 1.726,95						

M = Model		H x D = Hoogte x Diepte			I = Inhoud		G = Gewicht		S = Stralingsaandeel		Ex n = Exponent n		
Aantal elem.	Lengte in mm	Afgifte 55/45/20	Afgifte 75/65/20	€ wit € kleur	Afgifte 55/45/20	Afgifte 75/65/20	€ wit € kleur	Afgifte 55/45/20	Afgifte 75/65/20	€ wit € kleur	Afgifte 55/45/20	Afgifte 75/65/20	€ wit € kleur
2	157	188	371	306,85 368,22	234	455	357,62 429,16	265	533	421,95 506,33	348	676	586,08 703,31
3	237	271	535	357,75 429,29	339	661	423,88 508,66	369	743	504,13 604,94	482	938	700,20 840,26
4	317	352	695	408,65 490,36	441	861	490,13 588,16	473	952	586,30 703,54	615	1200	814,37 977,24
5	397	431	850	459,53 551,45	541	1058	556,38 667,67	577	1162	668,46 802,13	747	1461	928,49 1.114,19
6	477	509	1003	510,41 612,50	638	1252	622,63 747,16	680	1371	750,64 900,76	878	1723	1.042,64 1.251,15
7	557	585	1154	561,32 673,58	734	1443	688,89 826,68	782	1580	832,80 999,37	1009	1985	1.156,77 1.388,13
8	637	660	1302	612,20 734,66	828	1632	755,15 906,19	886	1790	914,97 1.097,97	1139	2247	1.270,91 1.525,10
9	717	735	1449	663,10 795,72	921	1819	821,40 985,68	988	1999	997,13 1.196,57	1268	2509	1.385,05 1.662,06
10	797	809	1594	713,97 856,79	1013	2004	887,65 1.065,20	1091	2209	1.079,30 1.295,17	1396	2771	1.499,20 1.799,02
11	877	882	1738	764,89 917,86	1104	2189	953,92 1.144,69	1193	2418	1.161,48 1.393,78	1524	3033	1.613,32 1.935,98
12	957	955	1881	815,78 978,94	1193	2371	1.020,17 1.224,22	1295	2628	1.243,65 1.492,37	1651	3295	1.727,46 2.072,96
13	1037	1028	2023	866,68 1.040,02	1281	2552	1.086,43 1.303,73	1397	2837	1.325,81 1.590,99	1777	3557	1.841,60 2.209,92
14	1117	1099	2163	917,58 1.101,06	1369	2733	1.152,68 1.383,22	1499	3047	1.407,99 1.689,59	1903	3819	1.955,74 2.346,89
15	1197	1170	2303	968,46 1.162,15	1455	2912	1.218,94 1.462,73	1600	3256	1.490,15 1.788,19			
16	1277	1241	2441	1.019,36 1.223,22	1541	3091	1.285,19 1.542,23	1701	3466	1.572,34 1.886,79			
17	1357	1311	2579	1.070,24 1.284,30	1631	3270	1.351,44 1.621,74	1804	3676	1.654,50 1.985,40			
18	1437	1381	2717	1.121,14 1.345,37	1720	3449	1.417,70 1.701,26						
19	1517	1451	2854	1.172,02 1.406,44	1809	3627	1.483,95 1.780,75						
20	1597	1520	2991	1.222,93 1.467,51	1897	3805	1.550,21 1.860,26						



ACCESSOIRES?

Zie pagina 202 - 207
ACCKNOPO2 ACCREK02
ACCKNOP08 ACCREK08

CONSOLES EN ZIJBEKLEDING:

Alle radiatoren zijn standaard voorzien van consoles en zijbekleding.

KLEUREN:

De prijs wit geldt voor RAL 9016.
De prijs kleur geldt voor de kleuren uit de kleurenwaai en kleurkaart, vak



AANSLUITINGEN:

(LET OP! Altijd opgeven bij bestelling)
Beschrijving zie pagina 115.

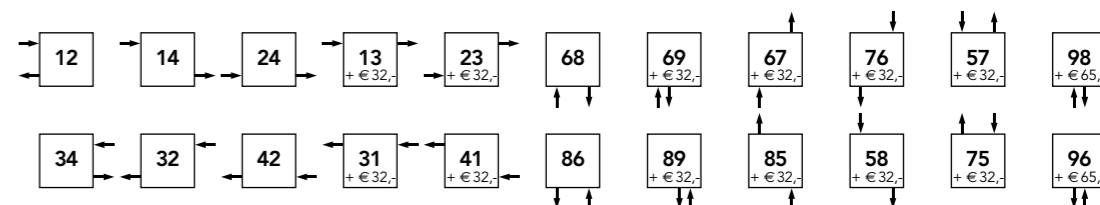

HOOGTE 2000MM

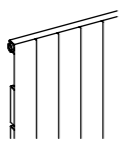
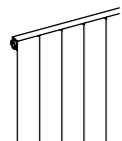

M	TV200-10	TV200-11	TV200-20	TV200-21
H x D	2000 x 53 mm	2000 x 61 mm	2000 x 61 mm	2000 x 101 mm
I	1,2 L/el.	1,2 L/el.	1,8 L/el.	2 L/el.
G	4,1 kg/el.	6,1 kg/el.	7,8 kg/el.	9,8 kg/el.
S	50%	35%	35%	20%
Ex n	1,3	1,3	1,3	1,3

HOOGTE 2200MM

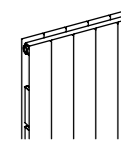
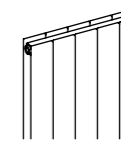
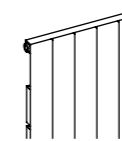
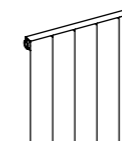

M	TV220-10	TV220-11	TV220-20	TV220-21
H x D	2200 x 53 mm	2200 x 61 mm	2200 x 61 mm	2200 x 101 mm
I	1,3 L/el.	1,3 L/el.	2 L/el.	2,2 L/el.
G	4,7 kg/el.	6,6 kg/el.	8,6 kg/el.	10,8 kg/el.
S	50%	35%	35%	20%
Ex n	1,3	1,3	1,3	1,3

M = Model		H x D = Hoogte x Diepte			I = Inhoud		G = Gewicht		S = Stralingsaandeel		Ex n = Exponent n		
Aantal elem.	Lengte in mm	Afgifte 55/45/20	Afgifte 75/65/20	€ wit € kleur	Afgifte 55/45/20	Afgifte 75/65/20	€ wit € kleur	Afgifte 55/45/20	Afgifte 75/65/20	€ wit € kleur	Afgifte 55/45/20	Afgifte 75/65/20	€ wit € kleur
2	157	208	408	316,01 379,20	254	498	370,69 444,85	295	592	442,59 531,09	381	743	614,75 737,71
3	237	301	589	370,34 444,43	369	723	441,09 529,32	409	821	531,14 637,37	526	1028	737,74 885,30
4	317	390	764	424,71 509,64	480	943	511,50 613,79	523	1050	619,68 743,60	671	1313	860,73 1.032,89
5	397	478	936	479,05 574,85	589	1158	581,90 698,29	636	1279	708,22 849,86	814	1598	983,72 1.180,46
6	477	563	1104	533,39 640,07	695	1370	652,29 782,76	749	1507	796,76 956,10	957	1883	1.106,70 1.328,06
7	557	647	1269	587,74 705,29	800	1579	722,70 867,24	862	1736	885,31 1.062,35	1100	2168	1.229,70 1.475,65
8	637	730	1433	642,10 770,51	904	1786	793,09 951,72	974	1965	973,84 1.168,61	1241	2453	1.352,69 1.623,23
9	717	812	1594	696,44 835,71	1006	1990	863,51 1.036,19	1087	2194	1.062,37 1.274,86	1382	2738	1.475,68 1.770,83
10	797	893	1754	750,80 900,95	1108	2194	933,89 1.120,67	1199	2422	1.150,94 1.381,12	1522	3023	1.598,67 1.918,41
11	877	974	1912	805,12 966,16	1207	2394	1.004,29 1.205,16	1311	2651	1.239,47 1.487,37	1662	3308	1.721,66 2.065,98
12	957	1053	2069	859,47 1.031,38	1306	2595	1.074,70 1.289,62	1422	2880	1.328,01 1.593,61			
13	1037	1132	2225	913,84 1.096,59	1404	2793	1.145,09 1.374,11	1534	3109	1.416,56 1.699,86			
14	1117	1210	2380	968,18 1.161,81	1501	2990	1.215,49 1.458,58	1645	3337	1.505,09 1.806,12			
15	1197	1288	2533	1.022,53 1.227,05	1597	3187	1.285,91 1.543,08	1756	3566	1.593,65 1.912,37			
16	1277	1365	2686	1.076,86 1.292,24	1693	3382	1.356,31 1.627,56	1867	3795	1.682,18 2.018,62			
17	1357	1443	2839	1.131,22 1.357,46	1790	3577	1.426,70 1.712,04						
18	1437	1520	2992	1.185,57 1.422,69	1888	3772	1.497,09 1.796,51						
19	1517	1598	3144	1.239,90 1.487,90	1985	3966	1.567,51 1.881,00						
20	1597	1675	3296	1.294,26 1.553,12	2082	4159	1.637,89 1.965,47						

M = Model		H x D = Hoogte x Diepte			I = Inhoud		G = Gewicht		S = Stralingsaandeel		Ex n = Exponent n		
Aantal elem.	Lengte in mm	Afgifte 55/45/20	Afgifte 75/65/20	€ wit € kleur	Afgifte 55/45/20	Afgifte 75/65/20	€ wit € kleur	Afgifte 55/45/20	Afgifte 75/65/20	€ wit € kleur	Afgifte 55/45/20	Afgifte 75/65/20	€ wit € kleur
2	157	228	443	325,55 390,64	274	540	389,43 467,31	326	652	464,60 557,52	415	812	645,29 774,34
3	237	329	640	383,52 460,22	397	784	464,96 557,95	450	900	559,38 671,27	571	1119	776,95 932,34
4	317	427	831	441,49 529,78	517	1022	540,46 648,57	572	1147	654,19 785,00	726	1426	908,60 1.090,34
5	397	523	1017	499,46 599,36	635	1255	615,99 739,20	695	1394	748,96 898,77	881	1733	1.040,28 1.248,32
6	477	616	1200	557,42 668,91	751	1485	691,50 829,81	818	1642	843,75 1.012,51	1034	2040	1.171,95 1.406,33
7	557	708	1380	615,41 738,49	865	1712	767,03 920,43	940	1889	938,56 1.126,25	1188	2347	1.303,60 1.564,33
8	637	798	1557	673,39 808,06	977	1936	842,55 1.011,04	1062	2136	1.033,34 1.240,00	1341	2654	1.435,27 1.722,32
9	717	887	1733	731,36 877,64	1089	2158	918,08 1.101,68	1184	2384	1.128,12 1.353,76	1493	2961	1.566,93 1.880,32
10	797	974	1906	789,33 947,21	1199	2378	993,57 1.192,31	1305	2631	1.222,92 1.467,51	1645	3268	1.698,60 2.038,32
11	877	1061	2078	847,30 1.016,78	1308	2596	1.069,12 1.282,93	1426	2878	1.317,71 1.581,24	1795	3575	1.830,26 2.196,31
12	957	1147	2249	905,27 1.086,35	1417	2813	1.144,62 1.373,56	1548	3126	1.412,51 1.695,01			
13	1037	1232	2418	963,29 1.155,92	1524	3028	1.220,16 1.464,18	1668	2273	1.507,29 1.808,76			
14	1117	1316	2586	1.021,26 1.225,48	1631	3242	1.295,66 1.554,80	1789	3620	1.602,08 1.922,50			
15	1197	1400	2753	1.079,23 1.295,04	1737	3455	1.371,19 1.645,42						
16	1277	1483	2919	1.137,19 1.364,62	1842	3667	1.446,71 1.736,05						
17	1357	1567	3085	1.195,16 1.434,18	1949	3879	1.522,21 1.826,66						
18	1437	1652	3251	1.253,14 1.503,76	2055	4091	1.597,74 1.917,29						
19	1517	1735	3416	1.311,11 1.573,34									
20	1597	1819	3581	1.369,09 1.642,92									



ACCESSOIRES?

Zie pagina 202 - 207
ACCKNOP02 ACCREK02
ACCKNOP08 ACCREK08

CONSOLES EN ZIJBEKLEDING:

Alle radiatoren zijn standaard
voorzien van consoles en
zijbekleding.

KLEUREN:

De prijs wit geldt voor RAL 9016.
De prijs kleur geldt voor de kleuren
uit de kleurenwaaier en kleurkaart, vak



AANSLUITINGEN:

(LET OP! Altijd opgeven bij bestelling)
Beschrijving zie pagina 115.

